

**COAX**  
CONNECTORS LTD

Product catalogue.

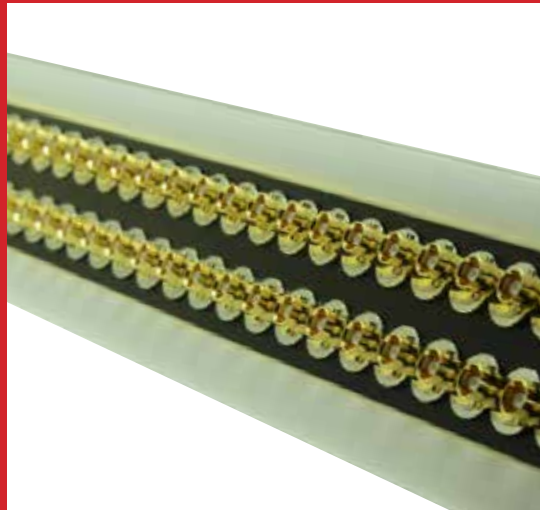

[www.coax-connectors.com](http://www.coax-connectors.com)



# Contents.

Section	Page
Welcome to COAX	3
Quality, performance and reliability by design	5
Cable assembly service	6
Applications	7
KORUS	8 - 9
Cable connector selection guide	11
BNC 50 ohm	12 - 25
BNC 50 ohm Reverse Polarity	26-27
BNC 75 ohm	28-49
Mini BNC 75 ohm	50-53
Micro BNC 75 ohm	54-63
TNC 50 & 75 ohm	64-75
TNC Reverse Polarity	76-79
F-Type	80-83
Euro TV	84
0.4/2.5 75 ohm	86-87
UHF	88-91
FME	92-94
N-Type 50 & 75 ohm	96-111
DIN Insert	112-113
SMA	114-133
SMA Reverse Polarity	134-135
SMB	136-145
SMC	146-149
Type 43 (SMZ)	150-155
HDC 43	156-157
UHDC 43	158-159
HDC/UHDC	160
SSMZ	161
Type 54	162-165
1.0/2.3 75 ohm	166-173
MCX	174-179
MMCX	180-185
BMA	186-187
Inter Series Adaptors	188-189
Joiners and Terminators	190-191
Cable Assemblies	192-193
Accessories & Tooling	194-196
Appendix (Cable Information)	198-203
Part Number Index	204-205

## In this catalogue.

- New Connectors
- More Standard Connectors
- Tooling
- Cable Assemblies

## New colour coded index.

Helping you to find the connector you need quickly.

## More information.

Increased detail to help you choose the right connector.

## Go online or call.

We are always here to help, at [www.coax-connectors.com](http://www.coax-connectors.com) or call +44 (0)20 8538 9090.

# Welcome to COAX.

COAX Connectors Ltd is a leading UK designer, manufacturer and supplier of high performance RF connectors.

Our products are underpinned by a high level of design expertise and an unfaltering commitment to service and quality. Having gone through a rigorous development process and extensive testing, the refined design of a COAX connector is sure to deliver the reliable and enduring performance your business needs.

Many of our connectors are available from stock for next day delivery, and where a bespoke solution is required COAX has the design capability to deliver a complete end to end service to satisfy your RF connector needs. Our designers can work with you from initial problem solving, through design concepts and prototyping, to supplying a qualified production part.

To complement our extensive range of RF connectors we offer a cable assembly service with rapid turnaround. Using this service not only saves you time, but also reduces the need for tooling, and ensures the correct method of termination.

With many years experience of working with customers and industry partners across various industries, COAX is well placed to assist with all your RF interconnectivity requirements. We look forward to working with you on your next project.

To discuss your RF connector or cable assembly requirement call +44 (0)20 8538 9090 or email: [info@coax-connectors.com](mailto:info@coax-connectors.com)



**COAX**  
CONNECTORS LTD

# CONNECTORS ASAP?



ORDER ANY TIME



ON THE MOVE ONLINE



QUICK DELIVERY



EXPERT ADVICE



ASSURED QUALITY

**TRY OUR NEW SERVICE FOR  
QUICK DELIVERY OF  
SMALLER QUANTITIES  
FROM STOCK**

**COAXDIRECT**  
QUALITY CONNECTORS DELIVERED

[www.coaxdirect.co.uk](http://www.coaxdirect.co.uk)

## Quality, performance and reliability by design.

Not all connectors are designed and manufactured to the same standard. We do not believe that our customers should have to compromise on quality, performance or reliability.

Our commitment to quality goes well beyond our accreditations to ISO 9001: 2015. & ISO 14001: 2015.

From the outset our connectors are designed and developed to perform to exacting standards. Using SolidWorks CAD software, backed up with an in-house test laboratory including HP network analyser, designs are proven using DFMA, FMEA and similar tools.

Our rigorous testing processes, which include high frequency testing, thermal shock testing, and accelerated age testing, ensure that the end result is a robust, cost effective product.

The COAX Connectors design department is staffed by a team of professionals who have decades of experience within leading global connector companies. On a daily basis they work closely with customers and industry partners to provide innovative product solutions.



95Q13579 & 95E13579

## Design services.

Whether you require fast turnaround of a bespoke connector for a specific application or a simple re-work of an existing design, our design department have the technical expertise to assist. Typical projects undertaken include:

- RF connector design
- Cable assembly design
- Engineered cost reductions
- Rapid prototyping
- Test and Qualification
- Re-design of obsolete products
- Reverse engineering
- Interconnect consultancy

Whatever your RF interconnectivity requirement, our designers can work with you to provide the answer.

for more information visit: [www.coax-connectors.com](http://www.coax-connectors.com)

## Cable assembly service.

What do you do if you need cable assemblies in a hurry?

To complement our extensive range of RF connectors we are pleased to offer a cable assembly service with rapid turnaround. Our service avoids the inconvenience of having to make cable assemblies yourself. Not only can it save you time, it also reduces the need for tooling and testing, eliminates scrap, and ensures correct method of termination.

Whether you want us to do everything for you, or whether you just need us to cut your cables to length ready prepared for your termination we can assist.

Contact us on +44 (0)20 8538 9090 to discuss your exact requirements.



## Applications.

Many COAX Connectors are deployed in locations where their performance is depended upon to carry vital data between sensitive and high performance equipment, 365 days a year, such as Broadcast, Security, Telecommunications, Medical or Defence applications.





# KORUS

the future of 75 ohm BNC connectors

## High Performance 75 ohm BNC Connectors.

Whether you're looking for 12G connectors for Ultra HD, or to future proof existing infrastructure, the 'KORUS' range of BNCs from COAX is the answer.

The industry leading 'low loss' performance of the next generation KORUS range permits high data signal transmission without distortion. With outstanding True 75 ohm performance for both 3G and 6G, the range also boasts a wide range of parts for 12G, which exceed the requirements of SMPTE standard ST2082-1.

PRBS10 & 15 testing has been carried out using our Korus BNC plugs to provide a 12G single channel at maximum transmission distances for many standard broadcast cables with zero bit error results. KORUS connectors are therefore the perfect choice for use in new UHD-SDI systems.

Finished in distinctive gold and black with gold plated inner and outer contacts, the KORUS range covers popular industry standard cables together with adaptors and PCB mount versions.

KORUS connectors are the latest addition to the COAX 75 ohm BNC range already widely used in broadcast applications for the transmission of HD-SDI 1080p, meeting previous SMPTE 292M & 424M standards and 4K Ultra HD picture quality.

### Key features:

- True 75 ohm - Low loss beyond 12GHz
- Distinctive Gold /Black
- 12G-SDI
- Zero bit errors when tested to PRBS10 & 15
- 4K Ultra HD



## KORUS plug return loss Now tested to 18GHz

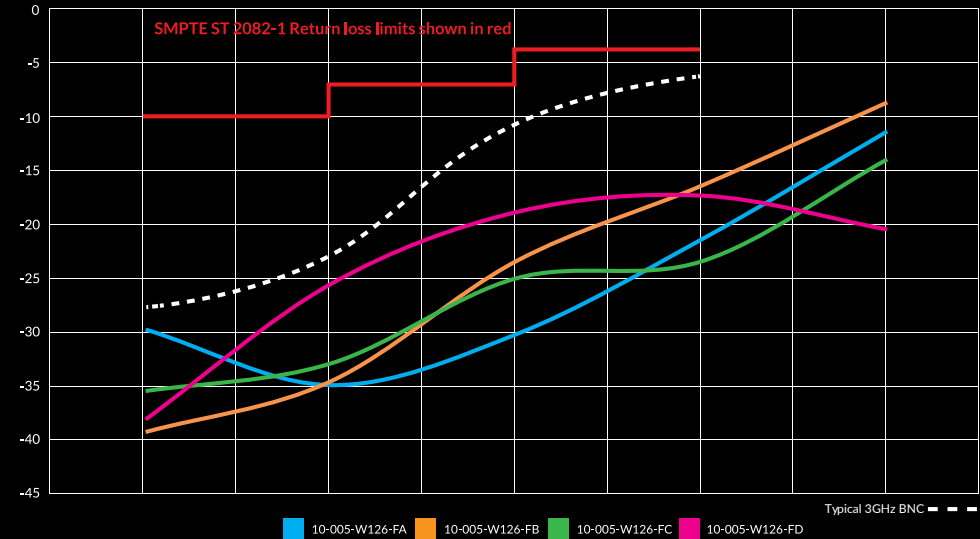

### Typical return loss.

	3GHz	6GHz	12GHz	18GHz
<b>10-005-W126-FA</b>	-34.94	-30.2	-21.36	-11.31
For cable types: Belden 1855ENH, 1855A, Draka 0.6/2.8 AF, Bryant BD SD01, Canford SDV, Percon VK5, Argosy Image360				
<b>10-005-W126-FB</b>	-34.58	-23.39	-16.36	-8.61
For cable types: Belden 1505A, Draka 0.8/3.7 AF, Bryant BD SD50A, Percon VK6, Argosy Image720				
<b>10-005-W126-FC</b>	-32.92	-24.99	-23.41	-13.91
For cable types: Belden 1694A, 1694F, Draka 1.0/4.8 AF, Bryant BD SD11, Canford SDV-L, Percon VK7, VK77, Argosy Image1000				
<b>10-005-W126-FD</b>	-25.52	-18.83	-17.29	-20.44
For cable types: Belden 7731A, Draka 1.6/7.3 AF, Bryant BD SD70, Argosy Image2000				

For details of the connectors featured above, see page 31.

Need help? Call us today: +44 (0)20 8538 9090  
or for more information visit: [www.coax-connectors.com](http://www.coax-connectors.com)

# About this catalogue.

This catalogue shows only a popular selection of connectors available from COAX.

Supplementary technical information and performance data for products is available at

[www.coax-connectors.com](http://www.coax-connectors.com)

## Cable connector selection.

On our product pages and in the appendix, we list an extensive range of cables, from a variety of manufacturers, that are suitable for use with our connectors.

All our cable connector part numbers include a 2 letter code indicating a 'Cable Group'. These cable groups include the cables that we know will fit any specific connector, the cable groups are listed in the appendix.

For example, the SMA connector with the part number 30-005-D3-AD is suitable for use with cable group 'AD' The appendix lists these cable groups together with the basic dimensions and materials of these cables.

In the appendix you will find cable group AD listed as follows -

Cable Type	Impedance	Jacket	Dielectric		Centre Conductor		Shielding
	$\Omega$	Diameter mm	Material	Diameter mm	Material	Diameter mm	
<b>Cable Group AD</b>							
KX22	50	2.5	PTFE	1.52	SCCS	0.51	Cu Braid
KX3	50	2.54	PE	1.5	CCS	0.48	Cu Braid
RG174	50	2.79	PE	1.52	BCCS	0.48	Cu Braid
RG188	50	2.67	PTFE	1.52	SCCS	0.51	Cu Braid
RG316	50	2.49	PTFE	1.52	SCCS	0.51	Cu Braid
Times LMR@100	50	2.79	PE	1.52	BCCS	0.46	Foil & Braid
URM95	50	2.3	PE	1.5	SCCS	0.46	Cu Braid
WBC100	50	2.67	PE	1.52	CCS	0.46	Foil & Braid

Important note: Cable manufacturers are continuously adding cables and updating their ranges so the cables listed are only a guide.

Connectors should be assembled to the cable by following the recommended assembly procedure. The assembly procedure number is listed against each connector, for example the connector mentioned above should be terminated according to APO01, which can be found at [www.coax-connectors.com/ap](http://www.coax-connectors.com/ap) or by contacting us directly.



Please note that any connector and cable combination should be tested before finalising your design or application to confirm suitability.



## BNC 50 ohm connectors.

50 ohm BNC connectors feature a simple bayonet coupling requiring only a quarter turn to connect or disconnect. The easy to use secure coupling makes BNC one of the most widespread general purpose connectors used in all electrical markets.

Our BNCs are designed to meet the requirements of IEC 61169-8 and typical applications include, instrumentation, security, telecom, broadcast, defence and aerospace.

The wide selection of body styles and configurations that support an extensive range of industry standard cables, makes BNC connectors, and their smaller variants, a popular choice.

Cable attachment methods include crimp, solder, clamp, Twist-On and Spring-Lock, to suit whatever requirements you have. Where required, appropriate tooling can be found in the Accessories & Tooling section of this catalogue.

COAX connectors offer an extensive range of both 50 ohm and 75 ohm BNCs, together with Mini and Micro (aka HD BNC) series, and True 75 ohm versions that can operate up to 12GHz.

### Key features:

- Bayonet Coupling
- Wide variety of configurations
- IP64 Sealed Interface
- Large cable range supported
- 50 & 75 ohm connectors may be mated together

BNC index	Page
<b>BNC 50 ohm</b>	<b>12-27</b>
Straight crimp plug	14
Straight solder clamp plug	15
Straight top hat solder clamp plug	15
Direct solder plug for semi-rigid cables	16
Right angle plug	17
Straight crimp jack	18
Straight crimp bulkhead jack rear mount	19
Straight solder jack front mount bulkhead	20
4 hole flange mount jack	21
Straight PCB jack	22
Right angle PCB jack	23
Adaptors	24-25
Reverse polarity straight crimp plug	26
Reverse polarity straight crimp bulkhead jack, rear mount	27
<b>BNC 75 ohm</b>	<b>28-49</b>
<b>Mini BNC 75 ohm</b>	<b>50-53</b>
<b>Micro BNC 75 ohm</b>	<b>54-63</b>

## Specification.

Electrical Specification		Environmental Specification	
Impedance	50 ohm	Operation temperature	-55 to +155 Deg C
Frequency Range	Up to 4 GHz	IP Rating (Mated)	IP64
Dielectric Withstand Voltage	1500 Veff		
Insulation Resistance	5000 M-ohm		
Mechanical Specification		Materials	
Design Standard	IEC-61169-8	Centre Contact	Phosphor Bronze/Brass
ROHS Compliant	Yes	Outer Contact	Brass
Mating Cycles	500	Insulator	PTFE/Delrin
Contact Retention	15N min	Bayonet Cap	Zinc
Mating Force	<20N max	Centre Contact Plating	Gold
Un-coupling Force	>2.2N min	Outer Contact Plating	Nickel
The above values are typical. Please check product data sheets for full details - see <a href="http://www.coax-connectors.com">www.coax-connectors.com</a> or call +44(0)20 8538 9090			

## BNC 50 ohm interface.

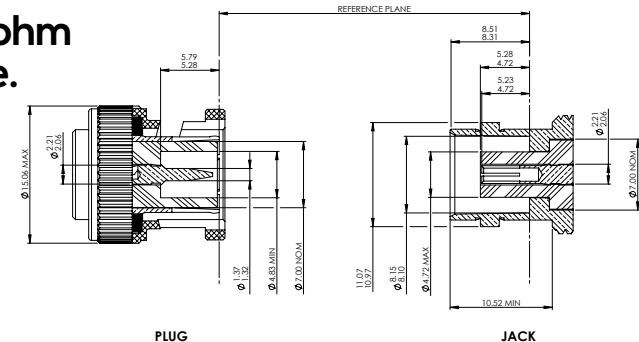

## BNC Reverse Polarity 50 ohm interface.

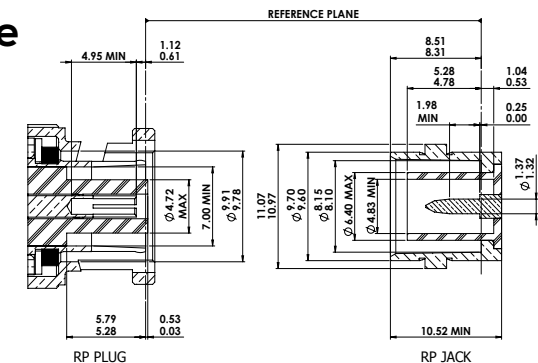

## Straight crimp plug.

These BNC plugs have gold plated crimped centre contacts and outer contacts with nickel plating.

For best performance centre contacts should be crimped, but may be soldered if required (for Times LMR@400 soldering is recommended).

See table below for crimp sizes; suitable tooling can be found in the Accessories & Tooling section of this catalogue.

Part Number	Cable Types	Cable Group	Assembly Procedure	Centre Contact	Outer Contact	Features
10-005-A0-AM	RG11,KX8	AM	AP001	2.54 Hex	10.9 Hex	
10-005-A0-AT	RG11RBS	AT	AP001	2.54 Hex	11.4 Hex	
10-005-A3-AH	RG58,RG141,Times LMR@195	AH	AP001	1.72 Hex	5.41 Hex	
10-005-A3-AN	RG213,URM67,KX4	AN	AP001	2.54 Hex	10.9 Hex	
10-005-A3-AO	RG214	AO	AP001	2.54 Hex	10.9 Hex	
10-005-A3-AP	URM202	AP	AP001	1.72 Hex	6.5 Hex	
10-005-A3-AU	RG400,RG142	AU	AP001	1.72 Hex	5.41 Hex	
10-005-A3-DB	Times LMR@240, Belden 155	DB	AP001	1.72 Hex	5.41 Hex	
10-005-A3-DE	See appendix for details on pages 198-203	DE	AP004/ AP001	3.25 Hex	10.9 Hex	** See Notes
10-005-B3-AK	RG223	AK	AP001	1.72 Hex	6.5 Hex	
10-006-A3-AD	See appendix for details on pages 198-203	AD	AP002	1.72 Hex	5.41 Hex	4 Part*
10-006-A3-AE	RD316,RD188	AE	AP002	1.72 Hex	5.41 Hex	4 Part*

\* For full details of assembly procedures, go to [www.coax-connectors.com/ap](http://www.coax-connectors.com/ap)  
 4 Part connectors include an insulated sleeve to provide additional support for small cables during assembly  
 \*\*Soldering of centre contact is recommended for optimum performance (AP004)

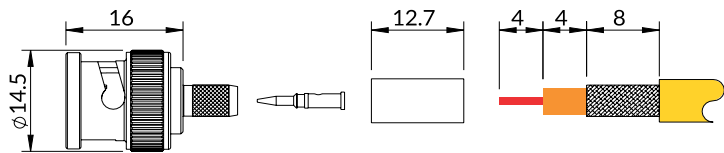

## Straight solder clamp plug.

Solder/Clamp plugs may be assembled without the need for specialist crimp tooling.

These BNC plugs have gold plated centre contacts and the outer is nickel plated.

Part Number	Cable Types	Cable Group	Assembly Procedure	Centre Contact	Outer Contact	Features
10-002-B3-AN	RG213,URM67,KX4	AN	AP016	Solder	Clamp	
10-002-A3-AH	RG58,RG141,Times LMR@195	AH	AP016	Solder	Clamp	

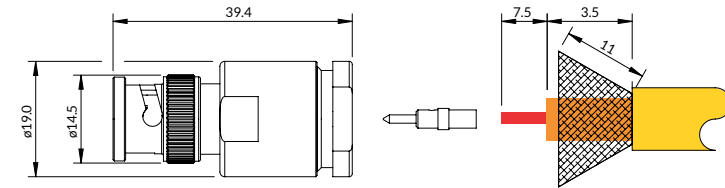

## Straight top hat solder clamp plug.

Top Hat clamp connectors offer improved cable retention strength over standard clamp connectors. No specialist tooling is required to assemble these plugs.

These connectors have gold plated center contacts with nickel plating on the outer.

Part Number	Cable Types	Cable Group	Assembly Procedure	Centre Contact	Outer Contact	Features
10-001-A3-AH	RG58,RG141,Times LMR@195	AH	AP010	Solder	Clamp	

For full details of assembly procedures, go to [www.coax-connectors.com/ap](http://www.coax-connectors.com/ap)

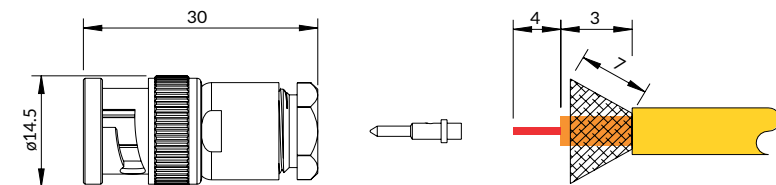



## Direct solder plug for semi-rigid cables.

These plugs are for direct soldering to standard .085" or .141" semi-rigid and conformable cables.

These connectors are fitted with gold plated centre contact and nickel plated outer contact. Accurate preparation of the cable will ensure optimum performance for this connector when fitted to semi-rigid or conformable cable.

The centre contact is soldered to the centre conductor of the cable and the copper outer jacket is soldered directly to the gold plated spigot on the rear of the body.



Part Number	Cable Types	Cable Group	Assembly Procedure	Centre Contact	Outer Contact	Features
10-014-D3-HA	RG405(.085")	HA	AP033	Solder	Solder	
10-014-D3-HB	RG402 (.141")	HB	AP033	Solder	Solder	

For full details of assembly procedures, go to [www.coax-connectors.com/ap](http://www.coax-connectors.com/ap)

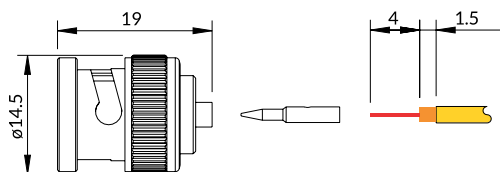

### Remember.

COAX Connectors can supply fully tested cable assemblies. Please contact us to discuss your requirements.

## Right angle plug.

BNC right angle plugs include plugs that are fully crimped where no soldering is needed, these are shown as Crimp/Crimp in the features below. Both crimped and soldered contacts are gold plated the outer conductor is crimped. The crimped contacts are in 2 parts, a loose contact is supplied for crimping to the conductor which mates with a fixed element during assembly to provide improved RF performance. The soldered contact versions have a 'capped aperture' in the square part of the body, through which the centre conductor is soldered.

Crimp sizes are shown in the table and suitable tooling can be found in the Accessories & Tooling section of this catalogue.



Part Number	Cable Types (for more see appendix)	Cable Group	Assembly Procedure	Centre Contact	Outer Contact	Features
10-104-A3-AH	RG58, RG141, Times LMR@195	AH	AP019	1.72 Hex	5.41 Hex	Crimp / Crimp
10-104-A3-AK	RG223	AK	AP019	1.72 Hex	6.5 Hex	Crimp / Crimp
10-106-A0-AD	RG174, RG188, RG316 Times LMR@100	AD	AP002	1.72 Hex	5.41 Hex	Crimp / Crimp 4 Part*
10-105-B3-AK	RG223	AK	AP017	Solder	6.5 Hex	Solder / Crimp
10-105-B3-DE	See appendix for details on pages 198-203	DE	AP017	Solder	10.9 Hex	Solder / Crimp

For full details of assembly procedures, go to [www.coax-connectors.com/ap](http://www.coax-connectors.com/ap)  
\*Items marked '4 Part' are for small cables and include a supporting sleeve for reliable assembly.

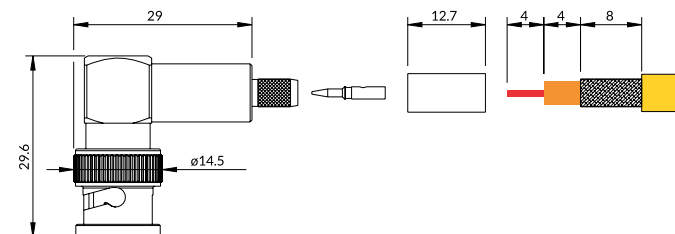

## Straight crimp jack.

Crimp cable jacks are available as either free cable or for bulkhead front mounting. The bulkhead mounted variants include a nut and lock washer.

These BNC jacks have a gold plated, crimped centre contacts and the outer conductor is hexagon crimped. The body and other metal parts are nickel plated.

Connectors marked '4 Part' include an insulated sleeve to provide additional support during assembly on to small diameter cables.

Crimp sizes are shown in the table and suitable tooling can be found in the Accessories & Tooling section of this catalogue.



Figure 1



Figure 2

Part Number	Cable Types (for more see appendix)	Cable Group	Assembly Procedure	Centre Contact	Outer Contact	Features
10-054-A3-AH	RG58, RG141, Times LMR®195	AH	AP001	1.72 Hex	5.41 Hex	Figure 1
10-050-A3-AH	RG58, RG141, Times LMR®195	AH	AP016	Solder/Clamp - Not shown.		
10-054-A3-AK	RG223	AK	AP001	1.72 Hex	6.5 Hex	Figure 1
10-054-A3-AN	RG213, URM67, KX4	AN	AP001	2.54 Hex	10.9 Hex	Figure 1
10-054-A3-AP	URM202	AP	AP001	1.72 Hex	6.5 Hex	Figure 1
10-055-A0-AD	See appendix for details on pages 198-203	AD	AP002	1.72 Hex	5.41 Hex	4 part, Figure 1
10-268-A3-AD	See appendix for details on pages 198-203	AD	AP001	1.72 Hex	5.41 Hex	Figure 2

For full details of assembly procedures, go to [www.coax-connectors.com/ap](http://www.coax-connectors.com/ap)

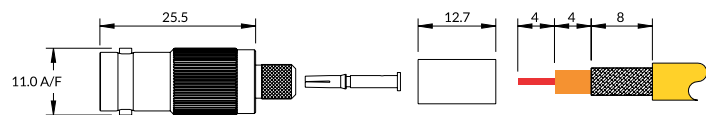

Figure 1

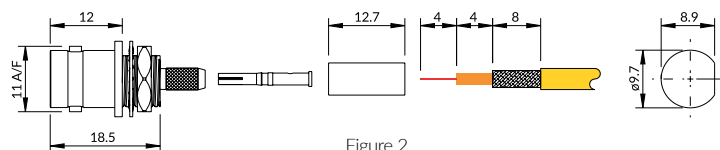

Figure 2

## Straight crimp bulkhead jack rear mount.

These rear mount crimp cable jacks are available for either direct mounting to a panel or with an insulated body.

Centre contacts are all gold plated and outer contacts are nickel plated.

See table below for crimp sizes, suitable tooling can be found in the Accessories & Tooling section of this catalogue.

All bulkhead mounted variants are fitted with a sealing ring giving IP64 protection against the panel, and include a nut and lock washer.



Figure 1



Figure 2

Part Number	Cable Types (for more see appendix)	Cable Group	Assembly Procedure	Centre Contact	Outer Contact	Features
10-254-A3-AH	RG58, RG141 Times LMR®195	AH	AP001	1.72 Hex	5.41 Hex	Figure 1
10-254-A3-AU	RG400, RG142	AU	AP001	1.72 Hex	5.41 Hex	Figure 1
10-254-B3-AK	RG223	AK	AP001	1.72 Hex	6.5 Hex	Figure 1
10-256-A0-AD	See appendix for details on pages 198-203	AD	AP002	1.72 Hex	5.41 Hex	Figure 1 4 Part*
10-264-B3-AA	RG178, RG196	AA	AP001	1.72 Hex	5.41 Hex	Figure 1 Bullet Contact
10-258-A3-AH	RG58, RG141 Times LMR®195	AH	AP001	1.72 Hex	5.41 Hex	Figure 2 Insulated
10-260-A3-AD	See appendix for details on pages 198-203	AD	AP002	1.72 Hex	5.41 Hex	Figure 2 Insulated 4 Part*

For full details of assembly procedures, go to [www.coax-connectors.com/ap](http://www.coax-connectors.com/ap)  
\*Items marked '4 Part' are for small cables and include a supporting sleeve for reliable assembly.

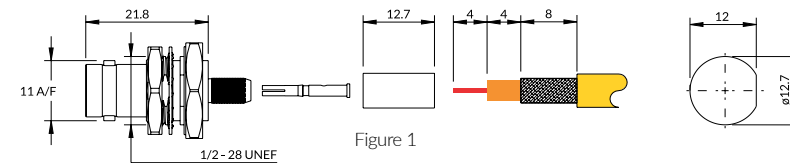

Figure 1

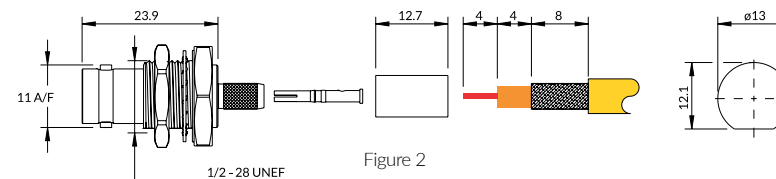

Figure 2

## Straight solder jack front mount bulkhead.

These bulkhead jacks come in both insulated and non-insulated versions. The threaded bodies have either single or double D flat to prevent rotation when mounted in a matching panel hole.

All connectors are supplied with a nut and lock washer, and where indicated a solder tag.

Centre contacts are gold plated, other body parts are plated with nickel.



Figure 1



Figure 2

Part Number	Drawing dimension (mm)			Centre Contact	Features
	A	B	C		
10-352-A3	10	4.7	12.5	Solder	Figure 1 Solder tag
10-352-A3-33	10	4.7	33	Solder	Figure 1 Long Body, solder tag
10-355-B3	10	4.7	12.5	Solder	Figure 1 Double D Flat, no solder tag
10-351-K3	See outline drawing below			Solder	Figure 2 Insulated mounting bush. No solder tag

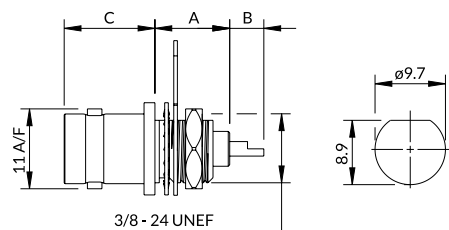

Figure 1

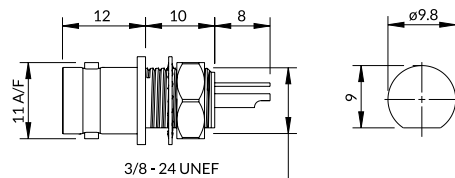

Figure 2

## 4 hole flange mount jack.

Cable mounted jack having the flange drilled with 4 mounting holes. A suitable panel cut out is shown in the outlines below.

Options include full crimp assembly to coaxial cable or with solder bucket termination.

Centre contacts are gold plated and the body nickel plated.

See table below for crimp sizes; suitable tooling can be found in the Accessories & Tooling section of this catalogue.

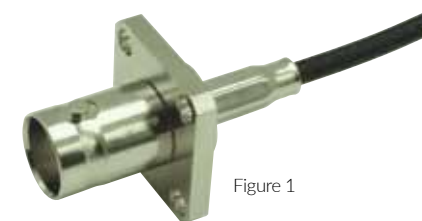

Figure 1



Figure 2

Part Number	Cable Types (for more see appendix)	Cable Group	Assembly Procedure	Centre Contact	Outer Contact	Features
10-278-B3-AD	RG174, RG188, RG316, Times LMR®100	AD	AP001	1.72 Hex	5.41 Hex	Figure 1
10-278-B3-AK	RG223	AK	AP001	1.72 Hex	6.5 Hex	Figure 1
10-371-B3	Not applicable			Solder		Figure 2

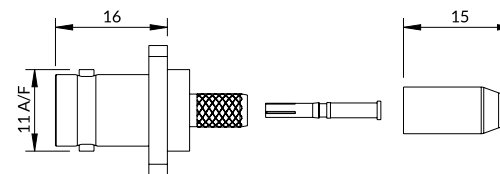

Figure 1

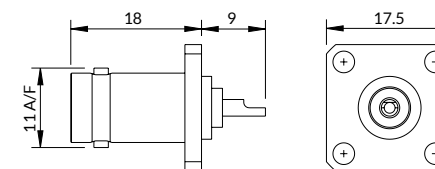
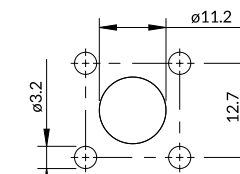
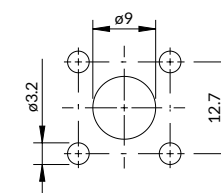

Figure 2



## Straight PCB jack.

Straight PCB through hole soldered connectors, with either round or a large square base. Square base version offers increased stability during assembly and wave soldering. Centre contacts are gold plated, bodies are nickel plated.

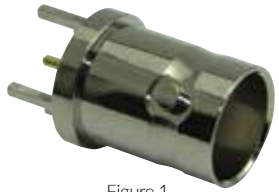

Figure 1

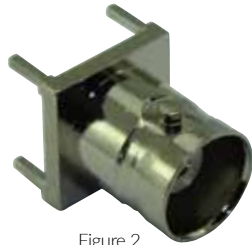

Figure 2

Part Number	Dimension A (mm)	Dimension B (mm)	Dimension C (mm)	Centre Contact	Outer Contact	Features
10-450-B3	13.8	4.5	N/A	Solder	Solder	Figure 1 Tray pack of 80
10-473-A3	12.9	4	5.3	Solder	Solder	Figure 2 Square Flange

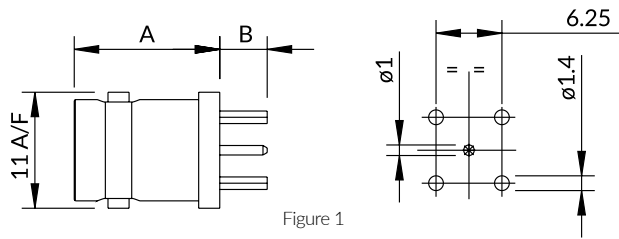

Figure 1

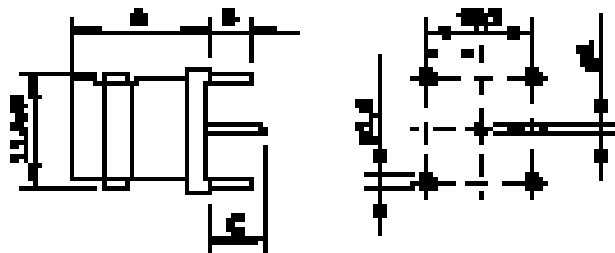

Figure 2

## Right angle PCB jack.

This selection of right angle PCB connectors includes low profile and insulated versions. Through hole solder pegs on the main body provide support to the connector during assembly and wave soldering.

All right angle bulkhead connectors are supplied with nut and lock washer. Centre contacts are gold plated, the outer contact and other metal body parts are gold or nickel plated.



Figure 1



Figure 2



Figure 3

Part Number	Dimension A (mm)	Dimension B (mm)	Centre Contact	Outer Contact	Features
10-466-A5	7.1	12.9	Solder	Solder	Figure 1 Low Profile
10-468-A5	8.2	15.2	Solder	Solder	Figure 2
10-468-D5	8.2	15.2	Solder	Solder	Figure 2 Gold plated
10-471-K5	6.9	13.1	Solder	Solder	Figure 3 Low Profile Insulated Body

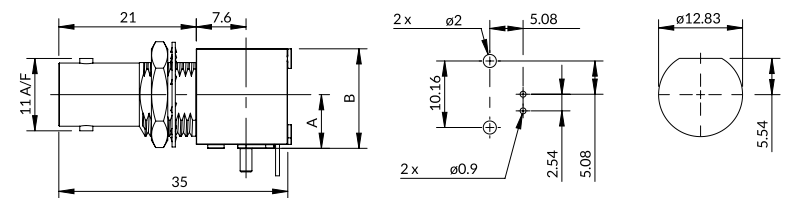

Figure 1, 2, 3



# Adaptors.

Adaptors in a range of configurations for connection within the BNC series.  
For connecting BNC to other coaxial connector types, see our range of Inter Series Adaptors.

All adaptors have gold plated centre contacts with nickel plated bodies.

Figure 1

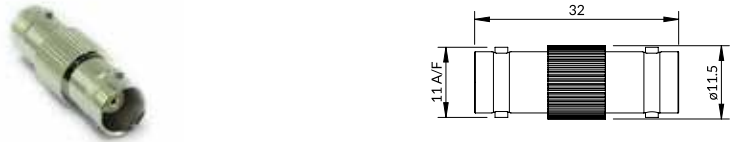

Figure 2

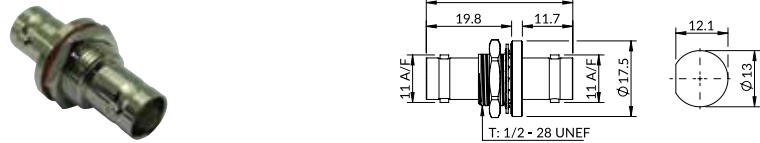

Figure 3

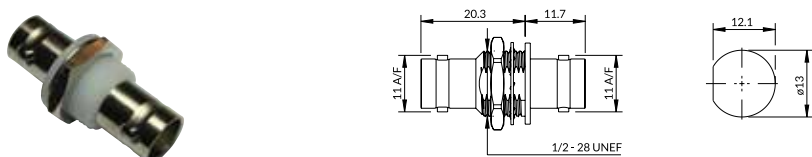

Figure 4



Figure 5



Figure 6



Figure 7



Figure 8



Figure 9



Part Number	Interface Arrangement	Interface Arrangement			Figure	Features
		Left	Centre	Right		
10-500-A3	Straight Adaptor	Jack		Jack	Fig. 1	
10-501-A3	Straight Adaptor	Jack		Jack	Fig. 2	Bulkhead Mount
10-503-A3	Straight Adaptor	Jack		Jack	Fig. 3	Insulated Bulkhead Mount
10-514-A3	Straight Adaptor		Plug	Plug	Fig. 4	
10-520-A3	Right Angle Adaptor	Plug		Jack	Fig. 5	
10-522-A3	3 Port Adaptor	Jack	Jack	Jack	Fig. 6	'T' Style
10-523-A3	3 Port Adaptor	Jack	Plug	Jack	Fig. 7	'T' Style
10-526-A3	3 Port Adaptor	Plug	Jack	Jack	Fig. 8	Goalpost style
10-527-A3	3 Port Adaptor	Jack	Jack	Plug	Fig. 9	'F' Style

## RP straight crimp plug.

50 ohm BNC Reverse Polarity plugs are identical to standard BNC plugs except that the interface gender is reversed.

Reverse polarity connectors are ideal where 2 independent lines are mounted on the same panel and it is important to ensure that they can not be incorrectly mated.

See table below for crimp sizes; suitable tooling can be found in the Accessories & Tooling section of this catalogue.

Part Number	Cable Types (for more see appendix)	Cable Group	Assembly Procedure	Centre Contact	Outer Contact	Features
11-005-A3-AH	RG58, RG141, Times LMR®195	AH	AP001	1.72 Hex	5.41 Hex	Reverse Polarity
11-005-A3-AD	See appendix for details on pages 198-203	AD	AP001	1.72 Hex	5.41 Hex	Reverse Polarity
11-005-A3-AK	RG223	AK	AP001	1.72 Hex	6.5 Hex	Reverse Polarity

For full details of assembly procedures, go to [www.coax-connectors.com/ap](http://www.coax-connectors.com/ap)

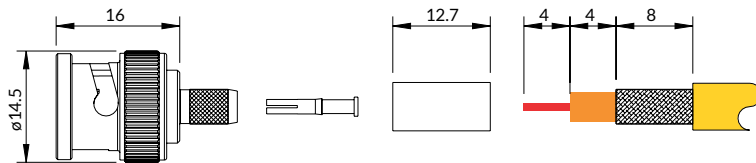

## RP straight crimp bulkhead jack, rear mount.

These reverse polarity jacks are identical to the standard versions except that the interface gender is reversed. They are ideal where 2 lines are mounted on the same panel and it is important to ensure that they can not be incorrectly mated.

All bulkhead mounted variants are fitted with a sealing ring giving IP64 protection against the panel, and include a nut and lock washer.

See table below for crimp sizes; suitable tooling can be found in the Accessories & Tooling section of this catalogue.

Part Number	Cable Types (for more see appendix)	Cable Group	Assembly Procedure	Centre Contact	Outer Contact	Features
11-254-A3-AH	RG58, RG141, Times LMR®195	AH	AP001	1.72 Hex	5.41 Hex	Reverse Polarity
11-254-A3-AD	See appendix for details on pages 198-203	AD	AP001	1.72 Hex	5.41 Hex	Reverse Polarity
11-254-A3-AK	RG223	AK	AP001	1.72 Hex	6.5 Hex	Reverse Polarity

For full details of assembly procedures, go to [www.coax-connectors.com/ap](http://www.coax-connectors.com/ap)

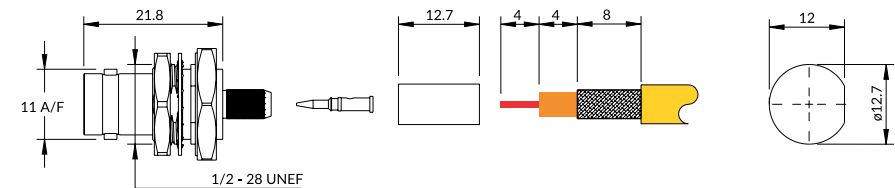

### Special note.

Other reverse polarity connectors are available in TNC and SMA series, details of which are shown at the end of the relevant section.



### Remember.

COAX Connectors can supply fully tested cable assemblies. Please contact us to discuss your requirements.



# BNC 75 ohm connectors.

COAX Connectors offer an extensive range of standard 75 ohm BNCs, together with Mini and Micro (aka HD-BNC) series. Many BNCs offered to the market as '75 ohm' are 50 ohm connectors that fit to 75 ohm cables and offer only limited RF and digital transmission capability. The True 75 ohm BNCs offered by COAX Connectors include the gold/black 'KORUS' range (see page 8) which are designed to perform at frequencies up to 12GHz and beyond.

Our 75 ohm BNCs are widely used in broadcast applications for the transmission of UHD-SDI, SMPTE ST 2082-1 and 4K picture quality.

75 ohm BNCs are also widely used in telecommunications and other general purpose applications all around the world, and our range will fit a wide variety of popular cables using either crimp, clamp and Twist-On assembly methods.

Many options for panel and PCB mounting are available including the popular edge mounted styles.

## Key features:

- True 75 ohm options
- Up to 12 GHz
- Wide range of cables covered
- Cable assemblies on request
- Versions to suit 12G for UHD-SDI
- PCB Connector with light pipe
- Machined plug outer contact for smooth mating
- High performance versions PRBS10 & 15 tested with zero bit errors



BNC index	Page
BNC 75 ohm	28-49
Crimp plugs	30-33
Straight solder/clamp and Twist-On plugs	34
Easy-Grip straight crimp plug	35
Right angle crimp plug	36
Straight crimp jack	38
Straight bulkhead rear mount crimp jack	39
Straight bulkhead front mount solder jacks	40
Straight PCB through hole solder	40-42
Right angle PCB bulkhead mount	43-45
PCB end launch bulkhead mount	46
Right angle PCB - bulkhead mount with light pipe	47
Terminator	47
Adaptors	48-49
Mini BNC 75 ohm	50-53
Micro BNC 75 ohm	54-63

## Specification.

Electrical Specification		Environmental Specification	
Impedance	75 ohm	Operation temperature	-55 to +155 Deg C
Frequency Range	Up to 12GHz	IP Rating (Mated)	IP64
Dielectric Withstand Voltage	1500 Veff		
Insulation Resistance	5000 M-ohm		
Mechanical Specification		Materials	
Design Standard	IEC-61169-8	Centre Contact	Brass/Phosphor Bronze
RoHS Compliant	Yes	Outer Contact	Brass
Mating Cycles	500	Insulator	PTFE/Delrin
Contact Retention	15N min	Bayonet Cap	Zinc/Brass
Mating Force	<20N max	Centre Contact Plating	Gold
Uncoupling Force	>2.2N min	Outer Contact Plating	Nickel/Gold

The above values are typical. Please check product data sheets for full details - see [www.coax-connectors.com](http://www.coax-connectors.com) or call +44(0)20 8538 9090

## BNC 75 ohm interface.

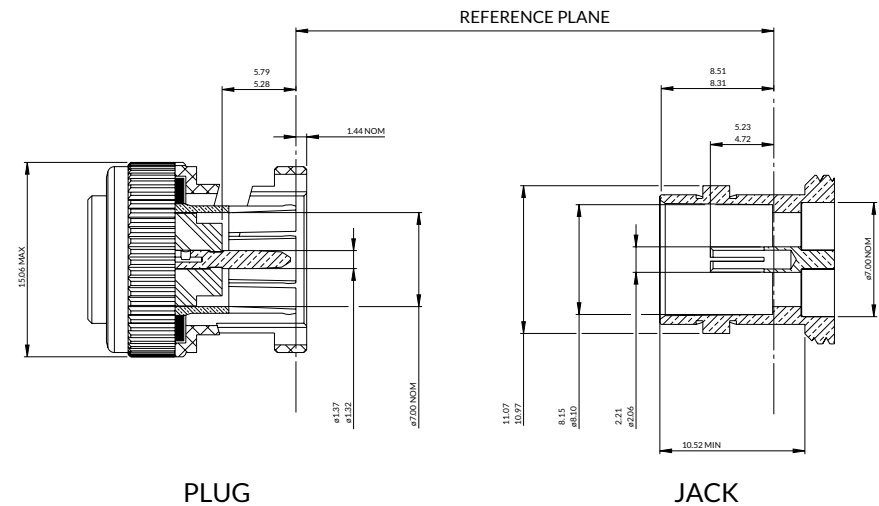

## New connectors.

We are regularly designing new connectors to enhance our range, if you can not find what you need, please contact us.



**KORUS**  
NOW ready for  
12GHz and beyond

## Crimp plugs.

Our extensive range of 75ohm BNC plugs cover a wide range of applications and frequencies. From our standard range of plugs that are used in general purpose applications up to 1GHz, to our latest 12GHz versions, you will find a COAX plug to suit your needs in the following pages.

The plugs listed, cover most popular cables. In this catalogue we feature many specialist cables used in the broadcast industry together with standard 75ohm cable. If the cable you use is not listed, please contact us.

### 12G-SDI crimp plugs are here

Now included are connectors designed for use in the latest Ultra High Definition Video applications, exceeding the requirements of SMPTE ST 2082-1 for 12G-SDI.

**PRBS10 & 15 testing has been carried out using our Korus BNC plugs to provide a 12G single channel at maximum transmission distances for many standard broadcast cables with zero bit error results.**

Within the 12GHz series are our 'KORUS' plugs featuring the distinctive black and gold design which can be used to distinguish between 12G and other connectors.

All COAX crimp plugs feature fully machined outer contacts for a smooth and robust mating.



## 12GHz crimp plugs.

These True 75ohm connectors are designed for use up to 12GHz. Inner and outer contacts are gold plated, coupling nuts are bright nickel plated, or in the case of the 'Korus' range they are black nickel. The crimp sleeve and inner contact are annealed to provide optimum crimping performance, and designs to suit the wide variety of cables listed, are available.

Outwardly, the True 75 ohm BNCs may not look any different from a general purpose BNC, however what is inside makes the difference. The design of the internal dimensions and the connector construction are carefully optimised to make our True 75 ohm BNC suitable for the demands of 'High Definition and Beyond'. Detailed performance data is available on request.

Part Number	Typical Cable Types (For more see appendix)	Cable Group	Assembly Procedure	Centre Contact	Outer Contact	Features	
10-005-D126-EF1	For details of suitable cables see appendix on pages 198 - 203	EF	AP001	1.07 Sq	4.52 Hex	Uses US standard crimp size	
10-005-D126-FA		FA	AP001	1.72 Hex	5.41 Hex		
10-005-D126-FB		FB	AP001	1.72 Hex	6.50 Hex		
10-005-D126-FB1		FB	AP001	1.07 Sq	6.48 Hex	Uses US standard crimp size	
10-005-D126-FC		FC	AP001	1.72 Hex	8.23 Hex		
10-005-D126-FC1		FC	AP001	1.07 Sq	7.06 Hex	Uses US standard crimp size	
10-005-B36-FD		FD	AP001	2.54 Hex	10.9 Hex		
10-005-W126-EF1		EF	AP001	1.07 Sq	4.52 Hex	'KORUS' (Black Coupling Nut) Uses US standard crimp size	
10-005-W126-FA		FA	AP001	1.72 Hex	5.41 Hex	'KORUS' (Black Coupling Nut)	
10-005-W126-FB		FB	AP001	1.72 Hex	6.50 Hex	'KORUS' (Black Coupling Nut)	
10-005-W126-FB1		FB	AP001	1.07 Sq	6.48 Hex	'KORUS' (Black Coupling Nut) Uses US standard crimp size	
10-005-W126-FC		FC	AP001	1.72 Hex	8.23 Hex	'KORUS' (Black Coupling Nut)	
10-005-W126-FC1		FC	AP001	1.07 Sq	7.06 Hex	'KORUS' (Black Coupling Nut) Uses US standard crimp size	
10-005-W126-FD		FD	AP001	2.54 Hex	10.9 Hex	'KORUS' (Black Coupling Nut)	
10-005-W126-FF		FF	AP001	1.72 Hex	8.23 Hex	'KORUS' (Black Coupling Nut)	
10-005-W126-FI		Belden 1794A	FI	AP019	2.54 Hex	10.9 Hex	'KORUS' (Black Coupling Nut)
10-005-W126-JB		Percon VK60 Silver+	JB	AP001	1.72 Hex	6.48 Hex	'KORUS' (Black Coupling Nut)
10-005-W126-JC		Percon VK70 Silver+	JC	AP001	1.72 Hex	8.23 Hex	'KORUS' (Black Coupling Nut)
10-005-W126-JD		Percon VK80 Silver+	JD	AP019	1.72 Hex	9.14 Hex	'KORUS' (Black Coupling Nut)
10-005-W126-JE		Percon VK90 Silver+	JE	AP019	2.54 Hex	10.9 Hex	'KORUS' (Black Coupling Nut)

For full details of assembly procedures, go to [www.coax-connectors.com/ap](http://www.coax-connectors.com/ap)

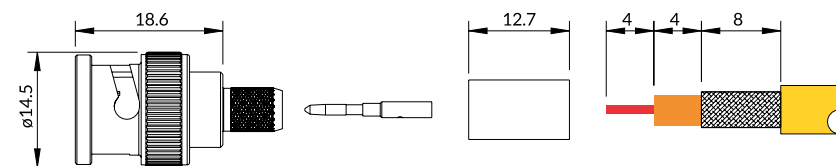

See following pages for more BNC plugs





### 3GHz crimp plugs.

The extensive range of 75 ohm BNCs includes a selection rated for use up to 3GHz. These connectors have a nickel plated outer contact and offer a lower cost solution when compared to the 12GHz versions with gold plated outer contacts. These True 75ohm connectors are suitable for high performance applications in Broadcast and Telecom, or in other communications equipment where a true 75ohm transmission line is required.

Inner contacts are gold plated and in addition to the standard bright nickel plated coupling nut, many versions are available with the distinctive black nickel plated coupling nut, see the table for details.

Outwardly, the True 75 ohm BNCs may not look any different from a general purpose BNC, however what is inside makes the difference. The design of the internal dimensions and the connector construction are carefully optimised to make our True 75 ohm BNC suitable for more demanding applications. Data sheets giving detailed performance of individual connectors are available on request or can be found on our website.

Part Number	Typical Cable Types (for more see appendix)	Cable Group	Assembly Procedure	Centre Contact	Outer Contact	Features
10-005-B36-AB	RG179, RG187, Belden179DT	AB	AP001	1.07 Sq	3.25 Hex	
10-005-T36-AB	RG179, RG187, Belden179DT	AB	AP001	1.07 Sq	3.25 Hex	Black Coupling Nut
10-005-B36-1-AB	RG179, RG187, Belden179DT	AB	AP001	1.07 Sq	5.41 Hex	Alternative crimp die required
10-005-B36-AI	RG59, RG62, URM70	AI	AP001	1.72 Hex	6.50 Hex	
10-005-T36-AI	RG59, RG62, URM70	AI	AP001	1.72 Hex	6.50 Hex	Black Coupling Nut
10-005-B36-BC	BT2003, PSF 1/3	BC	AP001	1.46 Hex	6.50 Hex	**
10-005-T36-BC	BT2003, PSF 1/3	BC	AP001	1.46 Hex	5.41 Hex	Black Coupling Nut
10-005-B36-BD	BT3002, TZC75024	BD	AP001	1.46 Hex	4.52 Hex	**
10-005-B36-BF	BT7000, RA7000	BF	AP001	1.46 Hex	5.18 Hex	
10-005-B36-BG	RA8000	BG	AP001	1.07 Sq	3.25 Hex	
10-005-B36-BH	735A, CT1320, SDV-M, 0.4/1.9AF	BH	AP001	1.72 Hex	4.52 Hex	
10-005-B36-CY	CYG014 (Silicone Jacket)	CY	AP001	1.72 Hex	6.50 Hex	
10-005-B36-EG	59U Quad	EG	AP001	1.72 Hex	8.23 Hex	
10-005-T36-EG	59U Quad	EG	AP001	1.72 Hex	8.23 Hex	Black Coupling Nut
10-005-B36-FA	See appendix for details on pages 198-203	FA	AP001	1.72 Hex	5.41 Hex	**
10-005-T36-FA		FA	AP001	1.72 Hex	5.41 Hex	Black Coupling Nut
10-005-B36-FB		FB	AP001	1.72 Hex	6.50 Hex	
10-005-T36-FB		FB	AP001	1.72 Hex	6.50 Hex	Black Coupling Nut
10-005-B36-FC		FC	AP001	1.72 Hex	8.23 Hex	**
10-005-T36-FC		FC	AP001	1.72 Hex	8.23 Hex	Black Coupling Nut
10-005-B36-FE	Belden 1505F, Bryant SD50F	FE	AP001	1.72 Hex	6.50 Hex	
10-005-B36-FF	Sommer 600-0214, Draka 1.2L/4.8DZ	FF	AP001	1.72 Hex	8.23 Hex	
10-005-B36-FH	Conduclif 14510 & 14511	FH	AP001	2.54 Hex	10.9 Hex	

For full details of assembly procedures, go to [www.coax-connectors.com/ap](http://www.coax-connectors.com/ap)  
\*\*Also available in bulk packs

### Standard crimp plugs.

These BNC plugs, whilst not strictly 75ohm by design, are adapted to fit 75ohm cables and are typically suitable for applications up to 1GHz. If higher performance is required, use one of the precision connectors on previous pages.

All these connectors have a gold plated centre contact, a nickel plated outer contact and coupling nut.

Data sheets giving detailed performance of individual connectors are available on request or can be found on our website.



Part Number	Typical Cable Types (For more see appendix)	Cable Group	Assembly Procedure	Centre Contact	Outer Contact	Features
10-006-A0-AB	RG179, RG187, Belden179DT	AB	AP002	1.72 Hex	5.41 Hex	4 Part*
10-005-A0-AF	Mini RG59 Black	AF	AP001	1.72 Hex	5.41 Hex	
10-005-A0-AG	Mini RG59 White	AG	AP001	1.72 Hex	5.41 Hex	
10-005-A0-AI	RG59, RG62, URM70	AI	AP001	1.72 Hex	6.50 Hex	
10-005-A0-AJ	RG59 DB	AJ	AP001	1.72 Hex	8.23 Hex	
10-005-B6-BA	BT2001	BA	AP001	1.46 Hex	5.18 Hex	
10-005-A6-BB	BT2002	BB	AP001	1.46 Hex	5.18 Hex	
10-005-A0-BC	BT2003, PSF 1/3	BC	AP001	1.46 Hex	6.50 Hex	
10-005-A7-BD	BT3002, TZC75024	BD	AP001	1.46 Hex	4.52 Hex	
10-005-A0-CA	CT100, RG6, WSC100	CA	AP001	1.72 Hex	8.23 Hex	
10-005-A0-CB	CT100RBS	CB	AP001	1.93 Hex	8.60 Hex	
10-005-A0-CC	CT125	CC	AP001	1.93 Hex	8.60 Hex	
10-005-A0-CD	CT125RBS	CD	AP001	1.93 Hex	9.96 Hex	
10-006-A0-CE	CT167	CE	AP002	1.72 Hex	10.9 Hex	4 Part*
10-006-A0-CF	CT167RBS	CF	AP002	1.72 Hex	11.94 Hex	4 Part*
10-005-B6-DL	Times LMR@200-75	DL	AP001	1.72 Hex	5.41 Hex	
10-005-A9-DN	Times LMR@400-75	DN	AP004/AP001	2.54 Hex	10.9 Hex	** See Notes
10-005-B3-EH	Flex3	EH	AP001	1.07 Sq	4.52 Hex	
10-005-A6-GA	PSF 1/2	GA	AP001	1.72 Hex	8.23 Hex	

For full details of assembly procedures, go to [www.coax-connectors.com/ap](http://www.coax-connectors.com/ap)  
\*Items marked '4 Part' are for small cables and include a supporting sleeve for reliable assembly  
\*\*Soldering of centre conductor is recommended for optimum performance (AP004)

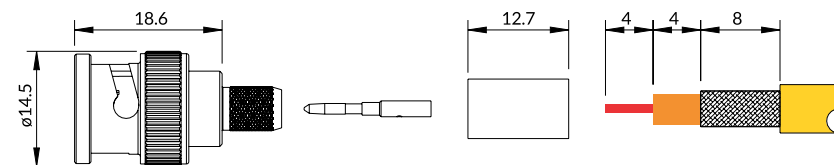

## Straight solder/clamp and Twist-On plugs.



Figure 1

Solder/Clamp plugs with Top Hat are simple to terminate; strip the cable to the dimensions shown, solder the contact and follow the assembly instructions to prepare the braid and clamp the jacket, complete the termination.

Twist-On BNC plugs do not require any special tooling to assemble them onto a cable. Simply strip the cable to the dimensions shown and follow the assembly instructions to complete the simple termination.

Centre contacts are gold plated, other body parts are nickel plated.

Figure 2

Part Number	Typical Cable Types (For more see appendix)	Cable Group	Assembly Procedure	Centre Contact	Outer Contact	Features
10-001-A0-AI	RG59, RG62, URM70	AI	AP010	Solder	Clamp	Figure 1
10-004-A0-AI	RG59, RG62, URM70	AI	AP043	Twist-On	Twist-On	Figure 2
10-004-A0-AJ	RG59 DB	AJ	AP043	Twist-On	Twist-On	Figure 2
10-004-A0-CB	CT100RBS	CB	AP043	Twist-On	Twist-On	Figure 2
10-004-A0-CD	CT125RBS	CD	AP043	Twist-On	Twist-On	Figure 2
10-021-A0-CA	CT100, RG6, WSC100	CA		Solder	Secure-Fit not shown, please contact COAX for data sheet	

For full details of assembly procedures, go to [www.coax-connectors.com/ap](http://www.coax-connectors.com/ap)

## Easy-Grip straight crimp plug - 6GHz.

BNC connectors are often mounted in difficult to access and closely spaced locations. Easy-Grip crimp plugs have an extended coupling nut that provides a larger surface area for holding the connector during mating and un-mating.

The simple design includes an Easy-Grip rear sleeve extension that is fitted onto the cable before assembling the cable to the connector. Once the connector is fully terminated by crimping the centre contact and crimp sleeve, the Easy-Grip sleeve is snapped into the rear of the main coupling nut.

Centre contacts are gold plated, other body parts are nickel plated.



Part Number	Typical Cable Types (For more see appendix)	Cable Group	Assembly Procedure	Centre Contact	Outer Contact	Features
10-005-EG-B66-FA	See appendix for details on pages 198-203	FA	AP047	1.72 Hex	5.41 Hex	Easy-Grip coupling nut
10-005-EG-B66-FB	See appendix for details on pages 198-203	FB	AP047	1.72 Hex	6.50 Hex	Easy-Grip coupling nut
10-005-EG-B66-FC	See appendix for details on pages 198-203	FC	AP047	1.72 Hex	8.23 Hex	Easy-Grip coupling nut

For full details of assembly procedures, go to [www.coax-connectors.com/ap](http://www.coax-connectors.com/ap)

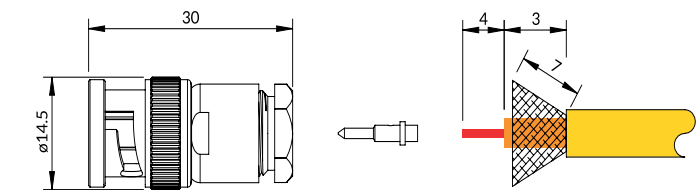

Figure 1

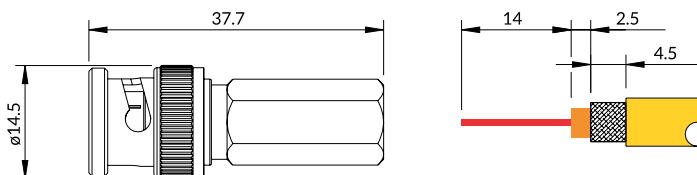
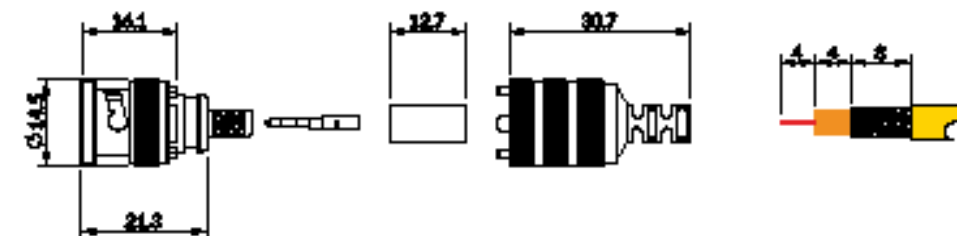

Figure 2



## Right angle crimp plug.

Right angle full crimp plugs feature a 2 part gold plated centre contact. No soldering is necessary, the loose contact is crimped to the cable and when inserted into the rear connector body it mates with the fixed contact. This design offers improved RF performance as the right angle portion of the contact is swept to provide a smooth transition.

Included in this section are 12GHz 'KORUS' versions that meet SMPTE ST2082-1 requirements for 12G broadcast.

See table below for crimp sizes; suitable tooling can be found in the Accessories & Tooling section of this catalogue.



Part Number	Typical Cable Types (for more see appendix)	Cable Group	Assembly Procedure	Centre Contact	Outer Contact	Features
10-104-B66-AB	RG179, RG187, Belden179DT	AB	AP019	1.07 Sq	3.25 Hex	
10-104-W66-AB	RG179, RG187, Belden179DT	AB	AP019	1.07 Sq	3.25 Hex	'KORUS' (Black Coupling Nut)
10-104-A0-AI	RG59, RG62, URM70	AI	AP019	1.72 Hex	6.50 Hex	
10-104-A0-BC	BT2003, PSF 1/3	BC	AP019	1.46 Hex	6.50 Hex	
10-104-A0-BD	BT3002, TZC75024	BD	AP019	1.46 Hex	4.52 Hex	
10-104-A0-FA	See appendix for details on pages 198-203	FA	AP019	1.72 Hex	5.41 Hex	
10-104-W66-FA	See appendix for details on pages 198-203	FA	AP019	1.72 Hex	5.41 Hex	'KORUS' (Black Coupling Nut)
10-104-W66-FB	See appendix for details on pages 198-203	FB	AP019	1.72 Hex	6.50 Hex	'KORUS' (Black Coupling Nut)
10-104-W66-FC	See appendix for details on pages 198-203	FC	AP019	1.72 Hex	8.23 Hex	'KORUS' (Black Coupling Nut)
10-106-A0-AB	RG179, RG187, Belden179DT	AB	AP002	1.72 Hex	5.41 Hex	4 Part*

For full details of assembly procedures, go to [www.coax-connectors.com/ap](http://www.coax-connectors.com/ap)  
 \*Items marked '4 Part' are for small cables and include a supporting sleeve for reliable assembly.

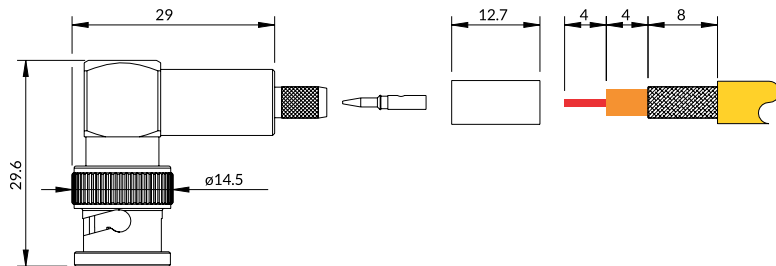

## Custom Designs

At COAX, we understand that not all customer applications can be satisfied using standard and off the shelf products. Our design and engineering specialists can evaluate such applications and propose solutions.

Typical examples of our successful resolution of customer problems include -

- New connector designs for saving space
- Adapting standard connectors to fit customer's housings
- Creating custom modules to improve handling
- Reducing insertion loss to improve bandwidth
- Ruggedized housing to seal and protect standard connectors

If you have an interconnect problem, please contact us to discuss how we might help.



Fibre from 'COAX'!  
Fully sealed shroud for fibre cable leads



Multi-way housings (2-11+) to make connections faster and more secure

## Straight crimp jack.

The range of full crimp straight jacks includes free cable variants and bulkhead mount variants shown on the page opposite.

Within the range is the option to choose either standard jacks or the True 75 ohm versions which include a gold plated jack for use up to 12GHz. The true 75 ohm options are specially designed to give improved performance when used at higher frequencies or in High Definition Broadcast systems.

See table below for crimp sizes; suitable tooling can be found in the Accessories & Tooling section of this catalogue.

The bulkhead rear mount jacks, on the opposite page, are all fitted with an IP64 panel seal and are supplied with a fixing nut and lock washer. Slotted circular fixing nuts (100-075) are also available, see page 195 for details.



Part Number	Typical Cable Types (For more see appendix)	Cable Group	Assembly Procedure	Centre Contact	Outer Contact	Features
10-054-D126-FA	See appendix for details on pages 198-203	FA	AP001	1.72 Hex	5.41 Hex	True 75 ohm 12GHz Gold plated
10-054-B36-FA	See appendix for details on pages 198-203	FA	AP001	1.72 Hex	5.41 Hex	True 75 ohm 3GHz
10-054-A0-FA	See appendix for details on pages 198-203	FA	AP001	1.72 Hex	5.41 Hex	
10-054-B36-AB	RG179, RG187, Belden179DT	AB	AP002	1.72 Hex	5.41 Hex	True 75 ohm 3GHz
10-055-A0-AB	RG179, RG187 Belden179DT	AB	AP002	1.72 Hex	5.41 Hex	4 Part*
10-056-B36-AB	RG179, RG187 Belden179DT	AB	AP002	1.72 Hex	5.41 Hex	True 75 ohm 3GHz 5 Part*
10-054-B36-AI	RG59, RG62, URM70	AI	AP001	1.72 Hex	6.50 Hex	True 75 ohm 3GHz
10-054-A0-AI	RG59, RG62, URM70	AI	AP001	1.72 Hex	6.50 Hex	
10-054-B36-BD	BT3002, TZC75024	BD	AP001	1.46 Hex	4.52 Hex	True 75 ohm 3GHz
10-054-B36-BC	BT2003, PSF 1/3	BC	AP001	1.46 Hex	6.50 Hex	True 75 ohm 3GHz
10-054-A0-BC	BT2003, PSF 1/3	BC	AP001	1.46 Hex	5.41 Hex	
10-055-B36-BF	BT7000, RA7000	BF	AP001	1.46 Hex	5.18 Hex	True 75 ohm 3GHz
10-056-B36-BG	RA8000	BG	AP002	1.46 Hex	3.25 Hex	True 75 ohm 3GHz 4 Part*
10-054-A0-AG	Mini RG59 White	AG	AP001	1.72 Hex	5.41 Hex	

For full details of assembly procedures, go to [www.coax-connectors.com/ap](http://www.coax-connectors.com/ap)

\*Items marked '4 Part' are for small cables and include a supporting sleeve for reliable assembly, '5 Part' has an additional sleeve.

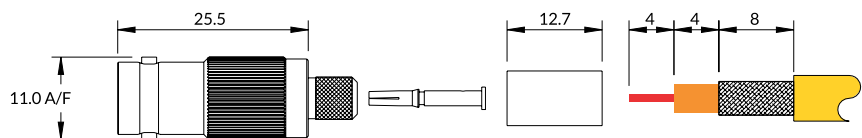

## Straight bulkhead rear mount crimp jack.

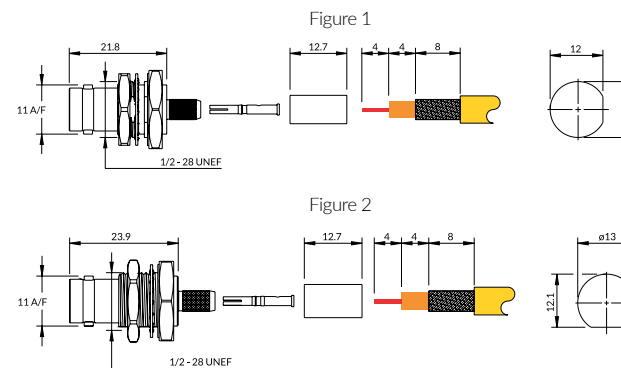

Figure 1

Figure 2

Part Number	Typical Cable Types (For more see appendix)	Cable Group	Assembly Procedure	Centre Contact	Outer Contact	Features
10-258-B36-FA		FA	AP001	1.72 Hex	5.41 Hex	True 75 ohm, 3GHz Insulated, Figure 2
10-258-B36-FA-W		FA	AP001	1.72 Hex	5.41 Hex	True 75 ohm, 3GHz Black Insulator, Fig 2
10-258-B36-FB		FB	AP001	1.72 Hex	6.50 Hex	True 75 ohm, 3GHz Insulated, Figure 2
10-258-B36-FB-W	See appendix for details on pages 198-203	FB	AP001	1.72 Hex	6.50 Hex	True 75 ohm, 3GHz Black Insulator, Fig 2
10-258-B36-FC		FC	AP001	1.72 Hex	8.23 Hex	True 75 ohm, 3GHz Insulated, Figure 2
10-258-B36-FC-W		FC	AP001	1.72 Hex	8.23 Hex	True 75 ohm, 3GHz Black Insulator, Fig 2
10-254-B36-FA		FA	AP001	1.72 Hex	5.41 Hex	True 75 ohm, 3GHz Figure 1
10-282-B36-BG	RA8000	BG	AP002	1.07 Sq	3.25 Hex	True 75 ohm, 3GHz 5 Part* Figure 1
10-254-A0-AG	Mini RG59 White	AG	AP001	1.72 Hex	5.41 Hex	Figure 1
10-254-A0-AI	RG59, RG62, URM70	AI	AP001	1.72 Hex	6.50 Hex	Figure 1
10-254-A0-BC	BT2003, PSF 1/3	BC	AP001	1.46 Hex	5.41 Hex	Figure 1
10-254-A0-FA	See appendix for details on pages 198-203	FA	AP001	1.72 Hex	5.41 Hex	Figure 1
10-254-A6-BD	BT3002, TZC75024	BD	AP001	1.46 Hex	4.52 Hex	Figure 1
10-256-A0-AB	RG179, RG187, Belden179DT	AB	AP001	1.72 Hex	5.41 Hex	4 Part*, Figure 1
10-258-A3-AI	RG59, RG62, URM70	AI	AP002	1.72 Hex	6.50 Hex	Black Insulator, Fig 2

For full details of assembly procedures, go to [www.coax-connectors.com/ap](http://www.coax-connectors.com/ap)

\*Items marked '4 Part' are for small cables and include a supporting sleeve for reliable assembly, '5 Part' has an additional sleeve.



## Straight bulkhead front mount solder jacks, insulated and non-insulated.



Figure 3



Figure 2



Figure 1

Options available include insulated and non-insulated styles. All are fitted with gold plated centre contacts, other body parts are nickel plated. All have D or double D flats on the body for anti rotation when mounted in a matching panel hole.

Centre conductor connection is to a solder bucket and the ground connection is through a ring solder tag or integral solder spill on the insulated version.

Part Number	Drawing dimension			Centre Contact	Features
	A	B	C		
10-350-A3	15.5	3.25	12.5	Solder	Figure 2 - Long Body
10-350-B6	10	4.7	12.5	Solder	Figure 1
10-355-B6	10	4.7	12.5	Solder	Figure 1 - Double D Flat No solder tag
10-351-K6	See Outline Figure 3			Solder	Figure 3 - Insulated

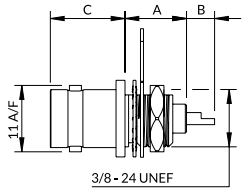

Figure 1 & 2

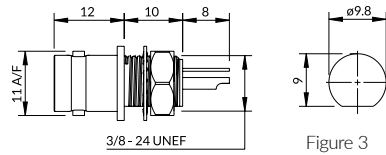
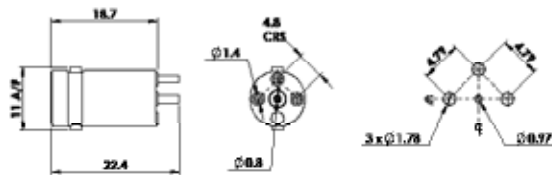

Figure 3

## Straight PCB True 75ohm with 3 round legs.

BNC True 75 ohm straight PCB jack has 3 round legs and is suitable for applications up to 4.5GHz. Gold plated centre contact, nickel plated brass body with a height above board of 18.7mm.



Part Number	Features
10-486-1-B36	Three round legs - True 75 ohm - 4.5 GHz

## Straight PCB through hole solder.

A selection of straight PCB connectors with a range of performance levels including a True 75 ohm version for use up to 3GHz.

Body styles with differing heights and base thickness, and one with the legs rotated through 45 degrees are included. Centre contacts are all gold plated.



Part Number	Drawing dimension		Features
	A	B	
10-450-B36-13.8	13.8	4.5	Figure 1 - 3GHz True 75 ohm
10-450-B6	13.8	4.5	Figure 1
10-491-B6	18.7	4.5	Figure 1
10-491-B6-45	18.7	4.5	As Figure 1 with legs 45° rotated relative to lugs
10-452-A6	27.8	4.5	Figure 2
10-452-B6	20.0	4.32	Figure 2

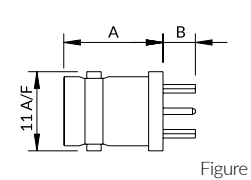

Figure 1

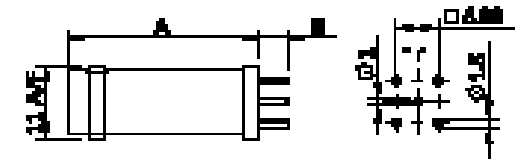

Figure 2

## Straight PCB True 75ohm with 3 round solder legs.

BNC True 75 ohm straight PCB jack has 3 round legs and is suitable for applications up to 4.5GHz. Gold plated centre contact, nickel plated brass body with a height above board of 13.45mm.



Part Number	Features
10-486-B36	Three round legs - True 75 ohm - 4.5 GHz

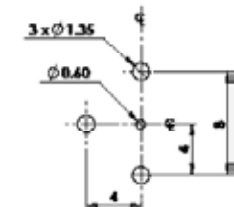
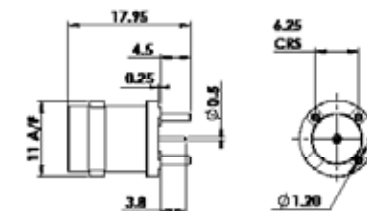

## Straight bulkhead PCB solder jack (6GHz).

PCB mounted jack that can be bulkhead fixed with the supplied nut and lock washer. Slotted circular fixing nuts (100-075) are also available, see page 195 for details.

This connector has 3 legs (2 ground + centre) in a straight line and double D flats to provide anti-rotation when bulkhead mounted.

Suitable for use in applications up to 6GHz.

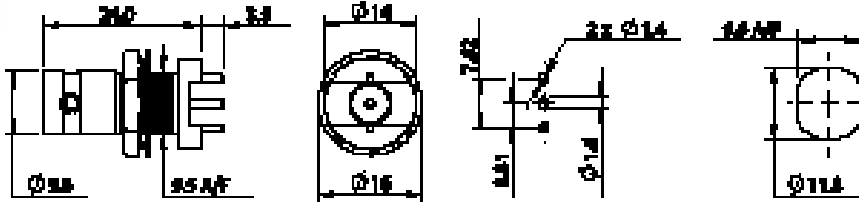

Part Number	Features
10-487-B36	True 75 ohm - 6 GHz

## Straight bulkhead PCB jack with panel seal (6GHz).

PCB mounted jack that can be bulkhead fixed with the supplied nut and lock washer. Slotted circular fixing nuts (100-075) are also available, see page 195 for details.

This connector has 3 legs (2 ground + centre) in a straight line and single D flats to provide anti-rotation when bulkhead mounted.

Suitable for use in applications up to 6GHz.

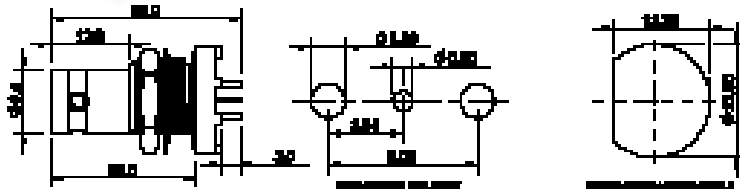

Part Number	Features
10-455-B36	True 75 ohm - 6 GHz with panel seal

## Right angle PCB through hole solder bulkhead mount.

This selection of right angle PCB connectors includes low profile and insulated versions.

Through hole solder pegs on the main body provide support to the connector which can be bulkhead mounted using the supplied nut and lock washer. Slotted circular fixing nuts (100-075) are also available, see accessories page for details.

Connectors are supplied complete with nut and lock washer. Centre contacts are gold plated, metallic body parts are nickel plated.

To assist during assembly 10-466-1-A8 is fitted with boardlock pegs that hold the connector firmly in place before soldering.



Figure 1

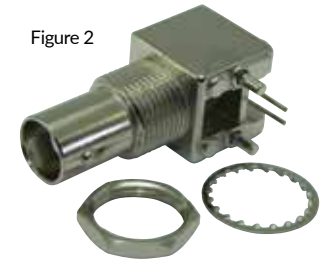

Figure 2



Figure 3

Part Number	Dimension A	Dimension B	Centre Contact	Outer Contact	Features
10-466-A8	7.1	12.9	Solder	Solder	Figure 1 - Low Profile
10-468-A8	8.2	15.2	Solder	Solder	Figure 2
10-466-1-A8	8.2	15.2	Solder	Solder	Figure 2 *
10-471-K1	6.9	13.1	Solder	Solder	Figure 3 - White insulated body
10-471-K6	6.9	13.1	Solder	Solder	Figure 3 - Black insulated body

\*10-466-1-A8 is fitted with Board Locks in place of solder pegs that are not shown in the picture

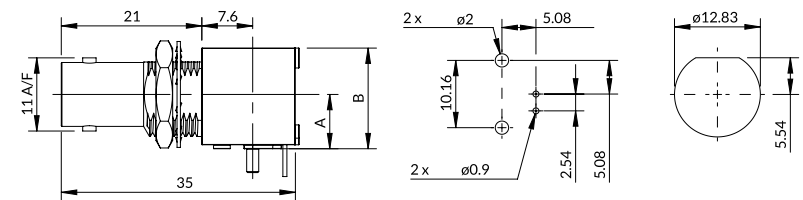

Figure 1, 2, 3



### Right angle PCB bulkhead mount.

This right angle PCB connector is designed to give True 75 ohm performance offering low return loss across the frequency range. The fully machined body, with either gold or nickel plating, and swept gold plated centre contact ensures optimum performance.

This connector is ideal for use in High Definition broadcast routers performing to SMPTE, and other 75 ohm low loss signal applications.

Part Number	Features
10-470-B36	3GHz Nickel plated
10-416-D66	3GHz Gold plated

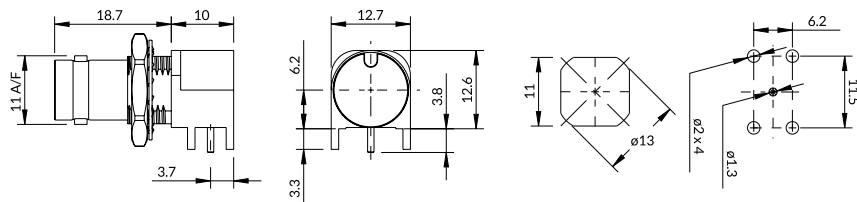

### Right angle PCB bulkhead mount, with surface mount centre contact.

This right angle PCB connector is designed to give True 75 ohm performance offering exceptional low return loss up to 4.5GHz. This connector has a gold plated surface mount centre contact and has a fully machined main body. Supplied with a slotted circular fixing nut. Suitable tooling can be found in the Accessories and Tooling section of this catalogue.

This connector is ideal for use in 4K High Definition broadcast routers performing to SMPTE, and other 75 ohm low loss signal applications.



Part Number	Features
10-482-B36	4.5 GHz nickel plated

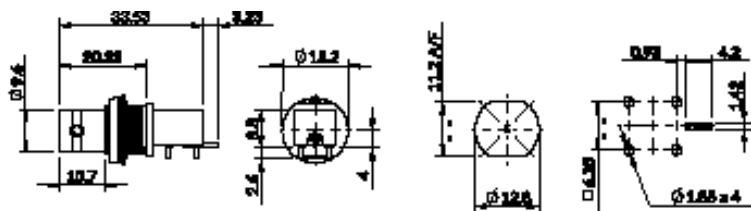

### Right angle PCB - 3GHz ultra low profile bulkhead mount.

This right angle PCB connector is designed to give True 75 ohm performance offering exceptional low return loss across the frequency range. The fully machined body, with nickel plating, and swept gold plated centre contact ensures optimum performance up to 3GHz and beyond. Slotted circular fixing nuts are also available.

The right angle body has a very low profile, with a height of only 10mm above the board. Fixing is through hole solder pegs.

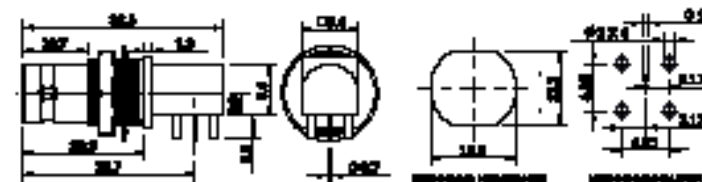

Part Number	Features
10-470-2-B36	3GHz nickel plated

### Right angle PCB through hole solder bulkhead mount.

True 75 ohm right angle bulkhead jack for applications up to 3GHz. The machined body is nickel plated and the contact is gold plated.

This connector is supplied complete with nickel plated lock washer and slotted circular nut. Suitable tooling can be found in the Accessories and Tooling section of this catalogue.

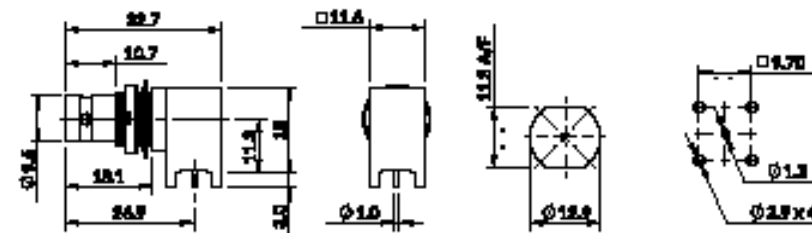

Part Number	Features
10-468-B36	True 75 ohm - 3GHz

## PCB end launch bulkhead mount, including 12GHz.

PCB edge mount connectors for a range of board thicknesses. These connectors are soldered directly to solder pads on the edge of the board, offering significant space saving when compared with right angle through hole soldered versions. Supplied with or without nut and lock washer for panel mounting. Alternative slotted circular fixing nuts (100-075) are also available, see accessories section for details.



Part Number	Centre Contact	Outer Contact	Dimension A (mm)	Contact length (mm)	Features
10-462-D126-1.6	Solder	Solder	1.7	2.5	Figure 1 for 1.6mm board 12GHz, gold plated body
10-462-1-D126-1.6	Solder	Solder	1.7	2.5	As above, without nut and washer
10-462-D126-2.2	Solder	Solder	2.2	2.5	Figure 1 for 2.2mm board 12GHz, gold plated body
10-462-1-D126-2.2	Solder	Solder	2.2	2.5	As above, without nut and washer
10-462-D36-1.6	Solder	Solder	1.7	2.0	Figure 1 for 1.6mm board 6GHz, gold plated body
10-462-D6	Solder	Solder	1.7		Figure 2 for 1.6mm board 1GHz, nickel plated body
10-462-B126-1.6	Solder	Solder	1.7	2.5	Figure 2 for 1.6mm board 12GHz, nickel plated body
10-462-B36-1.6	Solder	Solder	1.7	2.0	Figure 2 for 1.6mm board 3GHz, nickel plated body
10-462-B36-1.85	Solder	Solder	1.95	2.5	Figure 2 for 1.85mm board 3GHz, nickel plated body

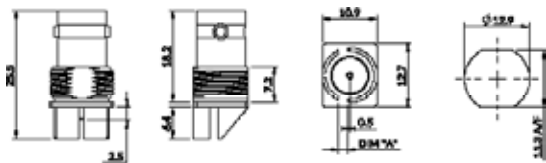

Figure 1

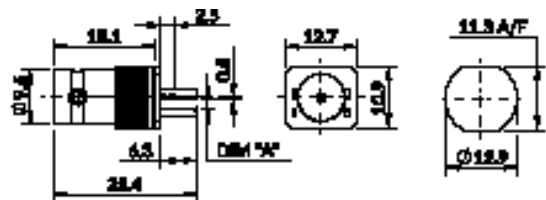

Figure 2

## Right angle PCB - bulkhead mount with light pipe.

This connector is designed with an insulator that allows light to pass through the interface. With an LED positioned on the PCB, behind the connector, the light source can be used to signal the current status of this port when unmated. Supplied with a lock washer and nut, slotted circular fixing nuts (100-075) are also available, see page 195 for details.

The LIGHT PIPE feature is ideal for locating the appropriate connector port on equipment panel arrays.



Part Number	Features
10-470-1-X36	3GHz Gold plated contact with nickel plated body

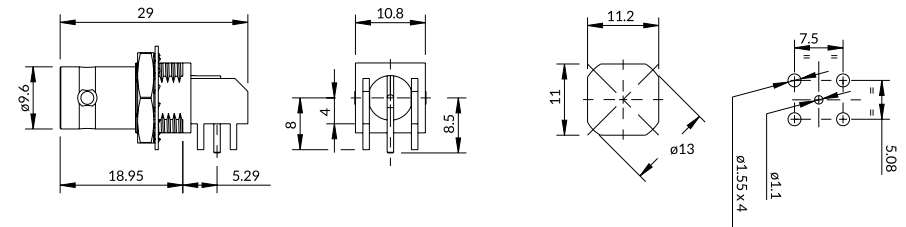

## BNC plug terminator.

For terminating unconnected 75ohm BNC lines, this terminator is accurate to + or - 1% of the stated impedance.

Available in both 3 & 12GHz versions.

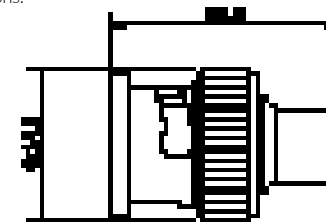

Part Number	Features
10-863-T6	3GHz Gold plated contact with nickel plated body
10-863-W126	12GHz 'KORUS' gold plated with black bayonet nut



## Adaptors.

Adaptors in a range of configurations for connection within the BNC series. All adaptors have gold plated centre contacts. For connecting BNC to other coaxial connector types, see our range of Inter Series Adaptors.

Figure 1

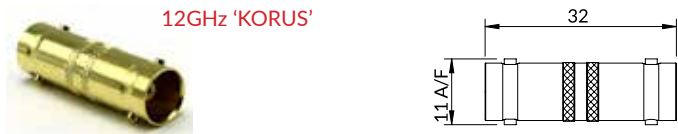

Figure 2

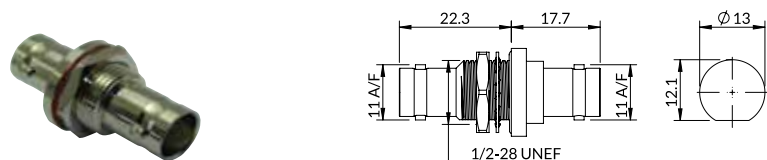

Figure 3

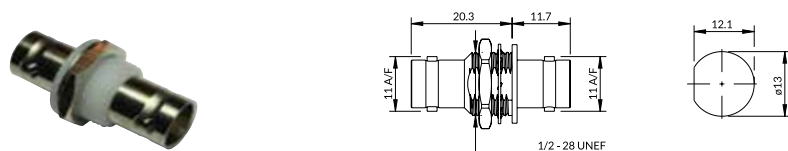

Figure 4

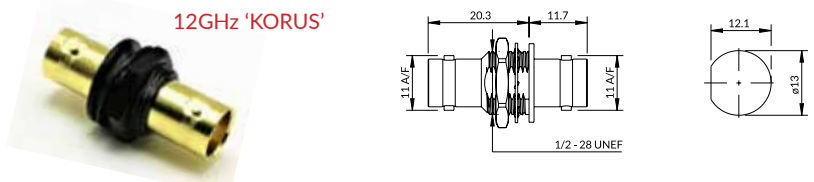

Figure 5

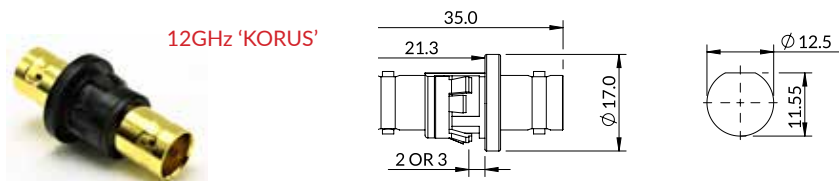

Figure 6

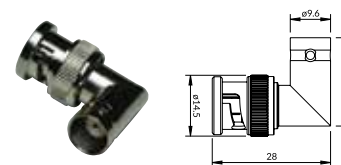

Figure 7

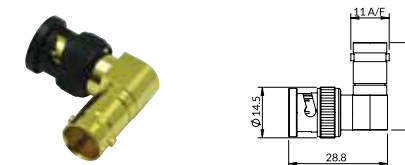

Figure 8

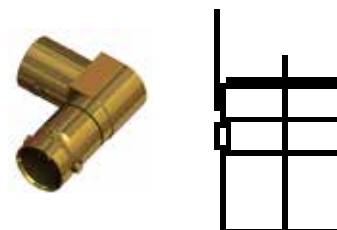
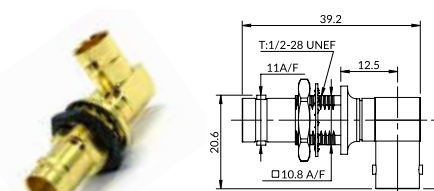

Figure 9



Part Number	Figure	Description	Interface Arrangement Left	Interface Arrangement Right	Features
10-500-B36	Fig. 1	Straight Adaptor	Jack	Jack	3GHz nickel plated
10-500-B66	Fig. 1	Straight Adaptor	Jack	Jack	6GHz nickel plated
10-500-D66	Fig. 1	Straight Adaptor	Jack	Jack	'KORUS' 6GHz see page 8 Gold plated
10-500-W126	Fig. 1	Straight Adaptor	Jack	Jack	'KORUS' 12GHz see page 8 Gold plated
10-501-A6	Fig. 2	Straight Bulkhead Adaptor	Jack	Jack	Bulkhead seal - nickel plated
10-501-B36	Fig. 2	Straight Bulkhead Adaptor	Jack	Jack	Bulkhead seal - 4.5GHz nickel plated
10-503-A6	Fig. 3	Straight Bulkhead Insulated Adaptor	Jack	Jack	Nickel plated Also available in pack of 50
10-503-B36	Fig. 4	Straight Bulkhead Insulated Adaptor	Jack	Jack	4.5GHz nickel plated
10-503-D66	Fig. 4	Straight Bulkhead Insulated Adaptor	Jack	Jack	'KORUS' 6GHz see page 8 Gold plated
10-503-W126	Fig. 4	Straight Bulkhead Insulated Adaptor	Jack	Jack	'KORUS' 12GHz see page 8 Gold plated
10-550-B36	Fig. 5	Straight Bulkhead Insulated Adaptor	Jack	Jack	Push-Fit to panel 4.5GHz nickel plated
10-550-W126	Fig. 5	Straight Bulkhead Insulated Adaptor	Jack	Jack	Push-Fit to panel 'KORUS' 12GHz see page 8 Gold plated.
10-520-A0	Fig. 6	Right Angle Adaptor	Plug	Jack	Nickel plated
10-520-B66	Fig. 6	Right Angle Adaptor	Plug	Jack	6GHz nickel plated
10-520-W66	Fig. 7	Right Angle Adaptor	Plug	Jack	'KORUS' 6GHz see page 8 Gold plated
10-519-B66	Fig. 8	Right Angle Adaptor	Jack	Jack	6GHz nickel plated
10-519-D66	Fig. 8	Right Angle Adaptor	Jack	Jack	'KORUS' 6GHz see page 8 Gold plated
10-538-W66	Fig. 9	Right Angle Bulkhead Adaptor	Jack	Jack	'KORUS' 6GHz see page 8 Gold plated



BNC index	Page
Mini BNC 75ohm	50-53
Straight plugs	52
Straight bulkhead jacks, rear mount	53
BNC 75 ohm	28-49
Micro BNC 75 ohm	54-63

# Mini BNC 75 ohm connectors.

Mini BNC 75 ohm RF connector series is a smaller version of the standard BNC. At around 40% smaller than BNC, the jacks can be mounted on a 14mm pitch, this series is ideal where space is at a premium yet performance cannot be compromised.

Suitable for use up to 3GHz, Mini BNC is used in telecom, broadcast and security markets.

## Key features:

- True 75 ohm options
- 3 GHz for HD Video
- Wide range of cables covered
- Cable assemblies on request

**Standard BNC**  
25 Connectors  
96mm Sq Area

**Mini BNC**  
36 Connectors  
44% more  
14mm Pitch

**Micro BNC**  
144 Connectors  
475% more  
8mm Pitch

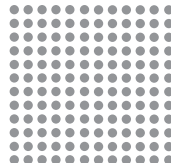
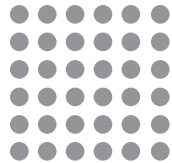

## New connectors.

We are regularly designing new connectors to enhance our range, if you can not find what you need, please contact us.

## Specification.

Electrical Specification		Environmental Specification	
Impedance	75 ohm	Operation temperature	-55 to +155 Deg C
Frequency Range	Up to 3GHz	IP Rating (Mated)	IP64
Dielectric Withstand Voltage	1000 Veff		
Insulation Resistance	1000 M-ohm		
Mechanical Specification		Materials	
Design Standard	FCL 12563	Outer Contact Plating	Nickel
RoHS Compliant	Yes	Centre Contact	Brass or Phosphor Bronze
Mating Cycles	500	Outer Contact	Brass
Contact Retention	10N min	Insulator	PTFE
Mating Force	6.7-22N max	Bayonet Cap	Brass
Un-coupling Force	3.3N min	Centre Contact Plating	Gold

The above values are typical. Please check product data sheets for full details - see [www.coax-connectors.com](http://www.coax-connectors.com) or call +44(0)20 8538 9090

## Mini BNC 75 ohm interface.

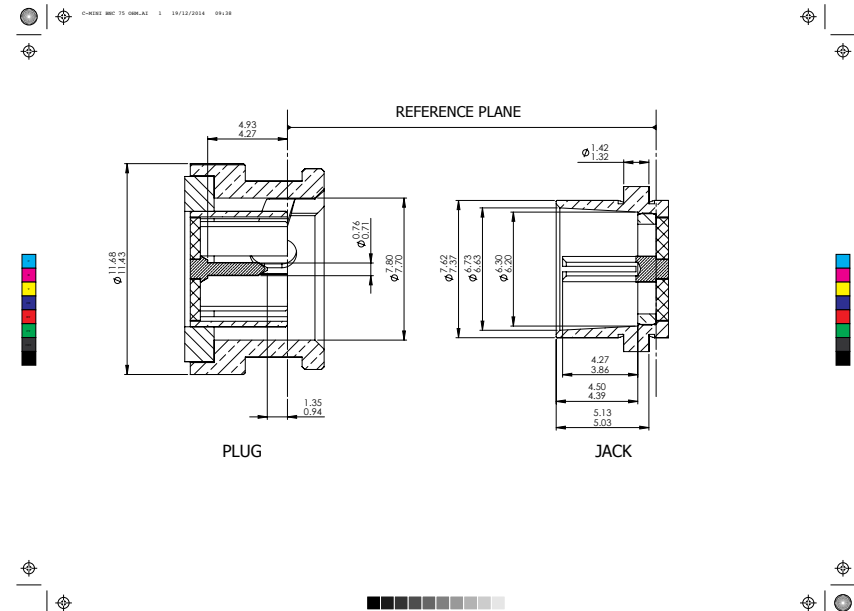



## Straight plugs.

Mini BNC cable plugs fit a range of popular communications cables and being significantly smaller than standard BNCs, they make the perfect choice when space is limited. See also the smaller Micro BNC in the previous catalogue section.

Crimp sizes are shown in the table and suitable tooling can be found in the Accessories & Tooling section of this catalogue. Centre contacts are gold plated.



Part Number	Typical Cable Types (For more see appendix)	Cable Group	Assembly Procedure	Centre Contact	Outer Contact
63-005-A0-AG	Mini RG59 White	AG	AP001	1.72 Hex	5.41 Hex
63-005-B6-AB	RG179, RG187 Belden179DT	AB	AP001	1.07 Sq	4.52 Hex
63-005-B6-BD	BT3002, TZC75024	BD	AP001	1.07 Sq	4.52 Hex
63-005-B6-BF	BT7000, RA7000	BF	AP001	1.07 Sq	5.18 Hex
63-005-B6-BG	RA8000	BG	AP001	1.07 Sq	4.52 Hex
63-005-B6-FA	1855ENH, 0.6/2.8AF BDS1, Image360	FA	AP001	1.07 Sq	5.41 Hex

For full details of assembly procedures, go to [www.coax-connectors.com/ap](http://www.coax-connectors.com/ap)

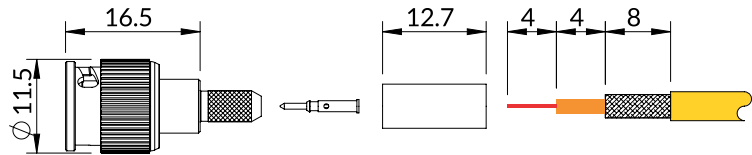

## Straight bulkhead jacks, rear mount.

Mini BNC bulkhead jacks fit a range of popular communications cables. Being 40% smaller than standard BNCs, they make the ideal choice when panel space is restricted.

See also the smaller Micro BNC in the previous catalogue section.

Crimp sizes are shown in the table and suitable tooling can be found in the Accessories & Tooling section of this catalogue. Centre contacts are gold plated.



Part Number	Typical Cable Types (for more see appendix)	Cable Group	Assembly Procedure	Centre Contact	Outer Contact
63-254-B6-AB	RG179, RG187, Belden179DT	AB	AP001	1.07 Sq	4.52 Hex
63-254-B6-BD	BT3002, TZC75024	BD	AP001	1.07 Sq	4.52 Hex
63-254-B6-BF	BT7000, RA7000	BF	AP001	Indent	5.18 Hex
63-254-B6-BG	RA8000	BG	AP001	1.07 Sq	3.84 Hex
63-254-B6-FA	1855ENH, 0.6/2.8AF, BDS1, Image360	FA	AP001	1.07 Sq	5.41 Hex

For full details of assembly procedures, go to [www.coax-connectors.com/ap](http://www.coax-connectors.com/ap)

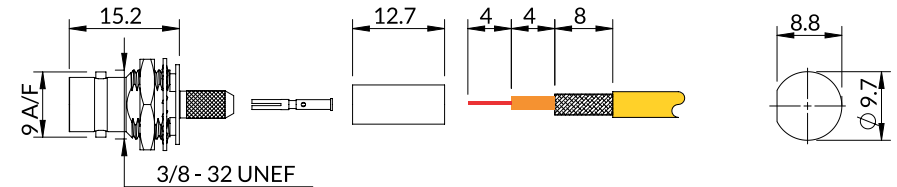



# Micro BNC (HD BNC)

Micro BNC (also known as HD-BNC) connectors are available with both 50 and 75 ohm interfaces. These connectors are designed for UHD Broadcast, telecom, HDcctv, instrumentation and similar applications that require high performance in a high density package. Micro BNC are fully intermateable with other series of HD-BNC/High density BNC with the same impedance, however it should be noted that 50 and 75ohm versions are not compatible.

The 75 ohm range of Micro BNC includes parts that meet the requirements of SMPTE ST 2082-1, these connectors are used in 12G UHD-SDI and are fit for Ultra HD 4K applications.

With a diameter of only 7.8 mm, mounting density is increased by more than 4 times when compared with a standard BNC. If space allows, the extended coupling nut (US Patent No. 9,071,013) enables the connectors to be mated and unmated without the use of a tool.

The small size is ideally suited to multi-way designs, the range now features a number of 2 way PCB mounted configurations for space and assembly time savings.

## Key features:

- Patented coupling nut for easy connection
- True 75 ohm options
- Patented coupling nut for easy connection
- Versions for 12G-SDI
- Up to 12 GHz
- Wide range of cables covered
- Identification rings on 50ohm versions



## New connectors.

We are regularly designing new connectors to enhance our range. If you can not find what you need, please contact us.

BNC index	Page
Micro BNC 75 ohm	54-63
Straight cable plugs	56-57
Straight crimp jacks	57
Straight PCB jacks	58
Right angle PCB jacks	58
End launch PCB jack including light pipe	59
Twin port stacked PCB modules	60-61
PCB push-on plug	62
75 ohm termination	63
Adaptors	63
<b>BNC 75 ohm</b>	<b>28-49</b>
<b>Mini BNC 75 ohm</b>	<b>50-53</b>

**Standard BNC**  
25 Connectors  
96mm Sq Area

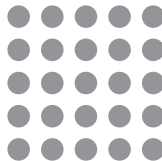

**Mini BNC**  
36 Connectors  
44% more  
14mm Pitch

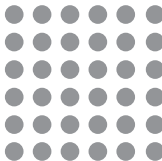

**Micro BNC**  
144 Connectors  
475% more  
8mm Pitch

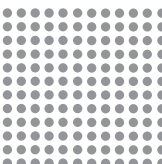

## Specification.

Electrical Specification		Environmental Specification	
Impedance	50 & 75 ohm	Operation temperature	-55 to +155 Deg C
Frequency Range	50 ohm up to 6GHz 75 ohm up to 12GHz	IP Rating (Mated)	IP64
Dielectric Withstand Voltage	1000 Veff		
Insulation Resistance	10000 M-ohm		
Mechanical Specification		Materials	
Design standard	FCL 12767	Centre Contact	Beryllium Copper
RoHS Compliant	Yes	Outer Contact	Brass
Mating Cycles	500	Insulator	PTFE
Contact Retention	10N min	Bayonet Cap	Brass
Mating Force	6.7-22N max	Centre Contact Plating	Gold
Un-coupling Force	3.3N min	Outer Contact Plating	Nickel/Gold

The above values are typical. Please check product data sheets for full details see [www.coax-connectors.com](http://www.coax-connectors.com) or call +44(0)20 8538 9090

## Micro BNC 50 ohm interface.



Note - 50 and 75 ohm versions of Micro BNC connectors are not compatible and permanent damage to the connector may occur if mated.

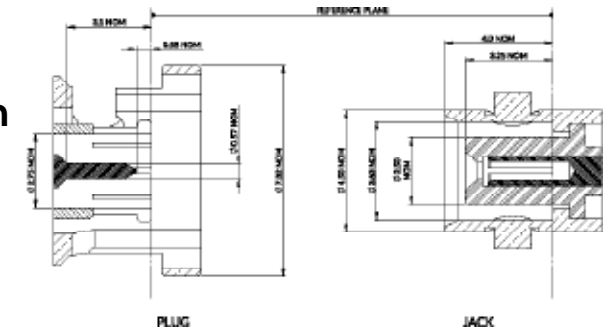

## Micro BNC 75 ohm interface.

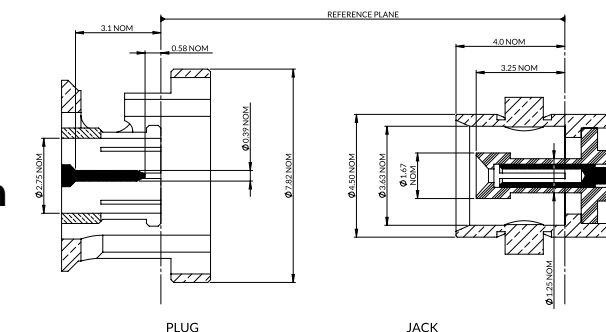



## Straight cable plugs.

Micro BNC straight crimp plugs are available in either 50 or 75 ohm versions. The True 75 ohm with many items conforming to SMPTE ST 2082-1 are suitable for use in broadcast 12G SDI applications or other industries requiring a small connector with low loss performance to 12GHz.

The unique patented COAX Connectors design has the coupling nut extended to the rear, which makes access for mating and un-mating easier. A special insertion and extraction tool (96-1132) that fits to this coupling nut is for use when packing density does not allow for finger access, details of this tool can be found in the Accessories & Tooling section of this catalogue.

Suitable crimp tooling can be found in the Accessories & Tooling section of this catalogue.

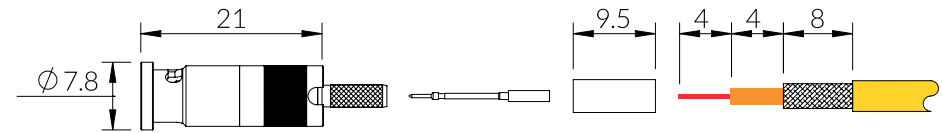

Figure 1

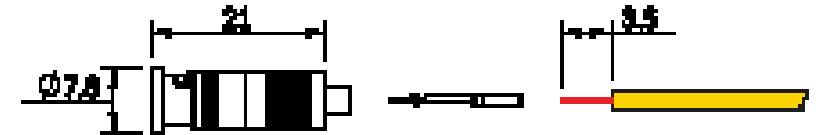

Figure 2

Part Number	Typical Cable Types (For more see appendix)	Ω	Cable Group	Assembly Procedure	Centre Contact	Outer Contact	Features
67-005-B66-AB	RG179, RG187, 179DT	75	AB	AP001	0.95 Sq	3.25 Hex	Figure 1 on next page
67-005-B66-BH		75	BH	AP001	0.95 Sq	4.52 Hex	Figure 1 on next page
67-005-B66-EF		75	EF	AP001	0.95 Sq	5.41 Hex	Figure 1 on next page
67-005-B66-EF1		75	EF	AP001	1.07 Sq	4.52 Hex	Figure 1 on next page US standard crimp sizes
67-005-B66-FA		75	FA	AP001	0.95 Sq	5.41 Hex	Figure 1 on next page
67-005-B66-1-FA		75	FA	AP001	0.95 Sq	5.41 Hex	Figure 1 on next page Centre contact plated 15µin gold
67-005-B66-FB		75	FB	AP001	0.95 Sq	6.48 Hex	Figure 1 on next page
67-005-B66-FB1		75	FB	AP001	1.07 Sq	6.48 Hex	Figure 1 on next page US standard crimp sizes
67-005-B66-FC		75	FC	AP001	1.07 Sq	7.06 Hex	Figure 1 on next page
67-005-B66-FE		75	FE	AP001	0.95 Sq	6.48 Hex	Figure 1 on next page
67-005-B66-JB	Percon VK60 Silver+	75	JB	AP001	0.95 Sq	6.48 Hex	Figure 1 on next page
67-005-B66-JC	Percon VK70 Silver+	75	JC	AP001	1.72 Hex	8.23 Hex	Figure 1 on next page
67-005-B3-AA	RG178, RG196	50	AA	AP001	0.95 Sq	3.25 Hex	Figure 1 on next page
67-005-B3-AD	See appendix for details on pages 198-203	50	AD	AP001	0.95 Sq	3.25 Hex	Figure 1 on next page
67-005-B3-AH	RG58, RG141, Times LMR@195	50	AH	AP001	1.72 Hex	5.41 Hex	Figure 1 on next page
67-005-B3-HA	RG405(.085")	50	HA	AP033	Solder	Solder	Figure 2 on next page For Semi-Rigid cable
67-005-B3-HD	.047" Semi-Rigid	50	HD	AP033	Solder	Solder	Figure 2 on next page For Semi-Rigid cable

For details of suitable cables see appendix at the end of this catalogue

For full details of assembly procedures, go to [www.coax-connectors.com/ap](http://www.coax-connectors.com/ap)  
 ⚠ 50 & 75 ohm connectors should not be mixed, or damage may occur, 50 ohm versions have ident rings for differentiation

## Straight crimp jack

Jacks are available for a wide range of standard broadcast cables with the option to crimp using either European or US die sizes.



Part Number	Typical Cable Types (For more see appendix)	Cable Group	Assembly Procedure	Centre Contact	Outer Contact	Features
67-054-B66-FA	See appendix for details on pages 198-203	FA	AP001	0.95 Sq	5.41 Hex	
67-054-B66-EF1	See appendix for details on pages 198-203	EF	AP001	1.07 Sq	4.52 Hex	US standard crimp sizes
67-054-B66-FB	See appendix for details on pages 198-203	FB	AP001	0.95 Sq	6.48 Hex	
67-054-B66-FB1	See appendix for details on pages 198-203	FB	AP001	1.07 Sq	6.48 Hex	US standard crimp sizes
67-054-B66-FC	See appendix for details on pages 198-203	FC	AP001	1.07 Sq	8.23 Hex	
67-054-B66-FC1	See appendix for details on pages 198-203	FC	AP001	1.07 Sq	7.06 Hex	US standard crimp sizes

For full details of assembly procedures, go to [www.coax-connectors.com/ap](http://www.coax-connectors.com/ap)

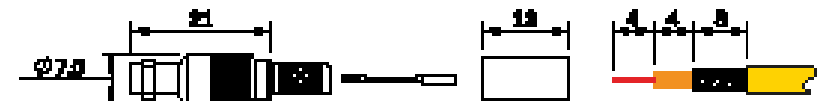

## Straight and Right angle PCB jacks.



Figure 1



Figure 2



Figure 3

The PCB options include straight bulkhead mount and a 3 leg version for use where board tracking limits the use of a standard 4 leg version. The 3 leg version is optimised for use up to 6GHz. The right angle versions are for bulkhead mounting and are available in several sizes for fixing to different board thicknesses. All connectors have gold plated centre contacts and bodies. The bulkhead mounted versions are supplied complete with a circular slotted fixing nut. A tool for tightening this nut (96-1135) can be found in the Accessories & Tooling section of this catalogue.

Part Number	Centre Contact	Outer Contact	Dimension A (mm)	Features
67-454-D66	Solder	Solder		Figure 1 - 4 Leg + Centre contact Bulkhead Mount
67-476-D66 12.25	Solder	Solder	12.25	Figure 2 - 3 Leg + Centre contact 6GHz
67-476-D66- 8.3	Solder	Solder	8.3	Figure 2 - 3 Leg + Centre contact 6GHz
67-468-D66	Solder	Solder	2.4	Figure 3
67-468-1-D66	Solder	Solder	3.7	Figure 3 - Centre contact - plated 15µ" gold
67-468-2-D66	Solder	Solder	2	Figure 3
67-468-3-D66	Solder	Solder	3.7	Figure 3

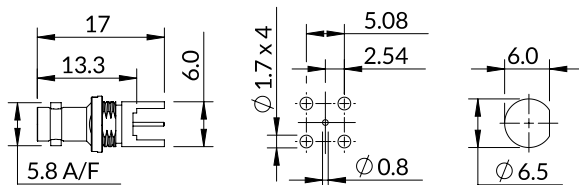

Figure 1

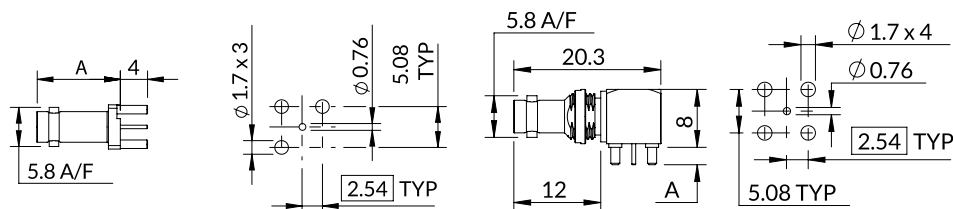

Figure 2

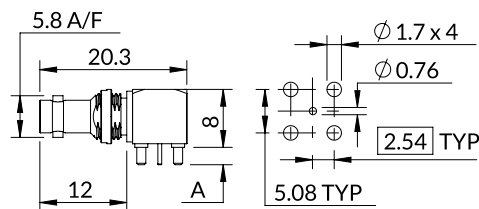

Figure 3

## End launch PCB jack including light pipe.

This 3GHz connector is available either as a standard edge mount connector, or one that is fitted with an insulator that allows light to pass through the interface. With an LED positioned on the PCB, behind the connector, the light source can be used to signal the current status of this port when unmatd.

The LIGHT PIPE feature is ideal for locating the appropriate connector port on equipment panel arrays.

For edge mount soldering to a 1.6mm thick PCB, the connector includes a circular slotted fixing nut for bulkhead mounting. A tool for tightening this nut (96-1135) can be found in the Accessories & Tooling section of this catalogue.



Part Number	Centre Contact	Outer Contact	Features
67-463-D66 1.6mm	Solder	Solder	Board Edge fitting to 1.6mm Board
67-463-1-D66-1.6mm	Solder	Solder	Board Edge fitting to 1.6mm Board with Light-Pipe insulator

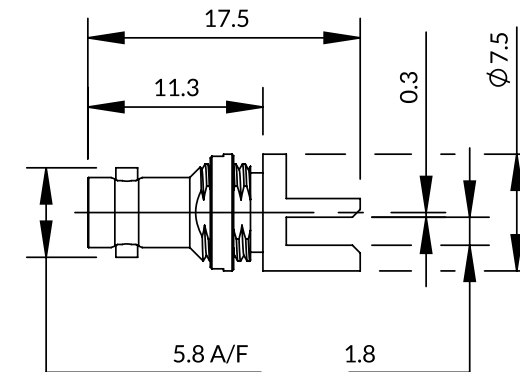



## PCB push-on plug (without bayonet nut).

These PCB plugs do not have the bayonet locking nut fitted so are ideal for board to board applications or for situations where locking is not required.



Figure 1



Figure 2

Part Number	Figure	Features
67-403-D126	Figure 1	Straight, surface mount, PCB jack
67-409-D126-1.6	Figure 2	End launch, PCB jack, for 1.6mm board

Figure 1

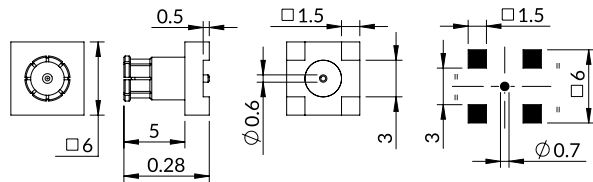
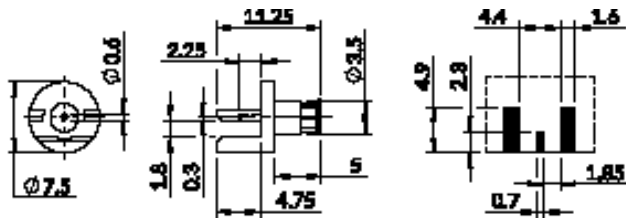

Figure 2



## 75 ohm termination.

This plug device provides a 75 ohm termination for any unused jack port.

This part has the same rear extended coupling nut (sleeve) used for the plug connectors. The sleeve incorporates a feature that allows it to be connected and disconnected with the standard tool (96-1132) used for cable plugs, see Accessories & Tooling section of this catalogue for more information.

Part Number	Centre Contact	Outer Contact	Features
67-863-B36	N/A	N/A	Return Loss: -26dB @ 12GHz

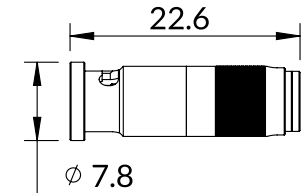

## Isolated Metal Thread Bulkhead Jack to Jack Adaptor (12GHz).

Bulkhead Jack to Jack Adaptor with a metal thread that is insulated from the main connector body. This true 75 ohm Adaptor is designed for 12G-SDI applications and general use up to 12GHz.



Part Number	Interface Arrangement Left	Interface Arrangement Right	Features
67-503-D126	Jack	Jack	Body insulated from panel

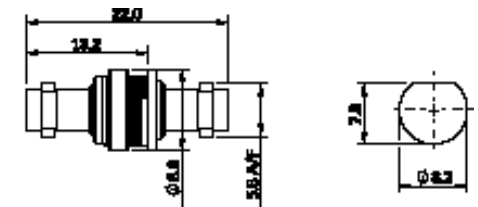

## Adaptor - Plug to Jack (6GHz)

Micro BNC Bulkhead Push-On plug to jack adaptor.

This is a bulkhead mounted adaptor without the coupling nut mechanism on the plug, for use as a push-on, non latching interface. Due to the absence of the coupling nut, the plug end will not latch.

This adaptor is designed to give low loss performance up to 6GHz.

Part Number	Interface Arrangement Left	Interface Arrangement Right	Features
67-512-B66	Plug	Jack	Without coupling nut

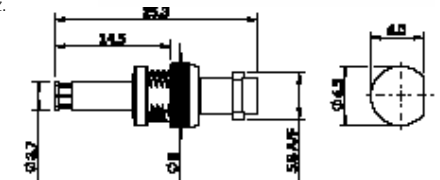





# TNC 50 & 75 ohm connectors.

TNC connectors featured in this section are a screw lock coupling version of the BNC connectors. Our TNC range includes both 50 and 75 ohm styles which are shown together on the following pages. The screw coupling enables TNC to be used at frequencies up to 11GHz (50 ohm) and for 12G SDI (75 ohm) in harsh environment situations. Widely used for antenna connections, TNC have many applications in avionics, defence, communications and general industrial markets. Reverse polarity TNC connectors are also available and shown at the end of this section.

## Key features:

- Threaded coupling
- IP 64 sealed interface
- Wide range of cables covered
- Cable assemblies on request
- Includes 75 ohm versions for use up to 12GHz



TNC 50 & 75 ohm	Page
Straight crimp plug	66
Straight solder plug	67
Right angle plug crimp & solder	68
Straight crimp jack	69
Straight rear mount bulkhead cable jack	70
Straight front mount bulkhead solder jack	71
Flange mount plug	71
Flange mount jack	72
End launch PCB jack	73
Right angle PCB bulkhead jack	73
Adaptors	74-75
TNC Reverse Polarity	76-79

## Specification.

Electrical Specification		Environmental Specification	
Impedance	50 & 75 ohm	Operation temperature	-55 to +155 Deg C
Frequency Range	50 ohm up to 11GHz 75 ohm up to 12GHz	IP Rating (Mated)	IP64
Dielectric Withstand Voltage	1500 Veff		
Insulation Resistance	5000 M-ohm		
Mechanical Specification		Materials	
Design Standard	IEC-61169-17	Centre Contact	Brass/Phosphor Bronze
RoHS Compliant	Yes	Outer Contact	Brass
Mating Cycles	500	Insulator	PTFE/Delrin
Contact Retention	15N min	Coupling Nut	Brass
Mating Force	<20N max	Centre Contact Plating	Gold
Un-coupling Force	>2.2N min	Outer Contact Plating	Nickel
The above values are typical. Please check product data sheets for full details - see <a href="http://www.coax-connectors.com">www.coax-connectors.com</a> or call +44(0)20 8538 9090			

## TNC 50 ohm interface.

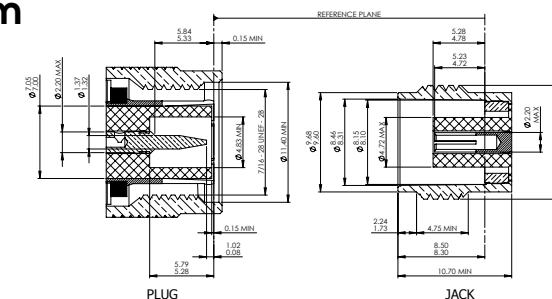

## TNC 75 ohm interface.

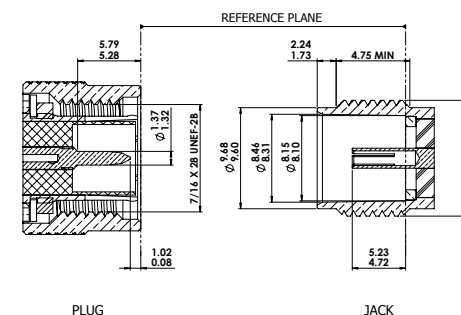

The Interface detail for Reverse Polarity is shown on page 76.



## New connectors.

New connectors are regularly being added to our range, if you cannot find what you need, please contact us.

## Straight crimp plug.

The 50 and 75 ohm crimp plugs shown here are designed to suit the wide variety of popular cables shown in the table.

The range now includes a selection of 75 ohm plugs capable of low loss performance up to, and beyond 12GHz.

The range now includes a selection of 75 ohm plugs capable of low loss performance up to, and beyond 12GHz.



Figure 1

Figure 2



## Straight solder plug.

As an alternative to the TNC crimp plugs shown opposite, these plugs are assembled using solder and clamp methods.

Included here is the direct solder variant for use on semi-rigid or conformable cable where the cable jacket is soldered onto the rear body of the connector.

Also included is a version of the plug for larger cables that has a hexagon coupling nut, which allows the interface to be tightened more effectively.

Appropriate tooling can be found in the Accessories & Tooling section of this catalogue.

Figure 1



Figure 2

Part Number	Cable Types (for more see appendix)	$\Omega$	Cable Group	Assembly Procedure	Centre Contact	Outer Contact	Features
13-005-A3-AH	RG58, RG141, Times LMR®195	50	AH	AP001	1.72 Hex	5.41 Hex	Figure 1
13-005-A3-AN	RG213, URM67, KX4	50	AN	AP001	2.54 Hex	10.9 Hex	Figure 1
13-005-A3-AO	RG214	50	AO	AP001	2.54 Hex	10.9 Hex	Figure 1
13-005-A3-AU	RG400, RG142	50	AU	AP001	1.72 Hex	5.41 Hex	Figure 1
13-005-B3-AH	RG58, RG141, Times LMR®195	50	AH	AP001	1.72 Hex	5.41 Hex	Figure 1
13-005-B3-AK	RG223	50	AK	AP001	1.72 Hex	6.5 Hex	Figure 1
13-005-B3-DB	Times LMR®240, Belden 155	50	DB	AP001	1.72 Hex	5.41 Hex	Figure 1
13-005-B3-DC	Times LMR®300	50	DC	AP001	1.72 Hex	5.41 Hex	Figure 1
13-005-B3-DE	See appendix for details	50	DE	AP001	3.25 Hex	10.9 Hex	Figure 1 **
13-006-A3-AD	RG174, RG188, RG316 Times LMR®100	50	AD	AP002	1.72 Hex	5.41 Hex	Figure 1, 4 Part *
13-005-A0-AB	RG179, RG187, Belden 179DT	75	AB	AP002	1.72 Hex	5.41 Hex	Figure 1, 4 Part*
13-005-A0-AI	RG59, RG62, URM70	75	AI	AP001	1.72 Hex	6.5 Hex	Figure 1
13-005-A0-AM	RG11, KX8	75	AM	AP001	2.54 Hex	10.9 Hex	Figure 1, 1GHz
13-005-D126-FA	See appendix at the end of the catalogue for details	75	FA	AP001	1.72 Hex	5.41 Hex	Figure 2, 12GHz
13-005-D126-FB		75	FB	AP001	1.72 Hex	6.50 Hex	Figure 2, 12GHz
13-005-D126-FC		75	FC	AP001	1.72 Hex	8.23 Hex	Figure 2, 12GHz
13-005-D126-FF		75	FF	AP001	1.72 Hex	8.23 Hex	Figure 2, 12GHz
13-025-A3-DE		75	DE	AP001	Solder	10.9 Hex	Hex coupling Nut Not shown

Part Number	Cable Types (for more see appendix)	$\Omega$	Cable Group	Assembly Procedure	Centre Contact	Outer Contact	Features
13-001-A3-AH	RG58, RG141 Times LMR®195	50	AH	AP010	Solder	Clamp	Figure 1
13-001-A3-AI	RG59, RG62, URM70	75	AI	AP010	Solder	Clamp	Figure 1 75 ohm
13-001-A3-DE	See appendix for details on pages 198-203	50	DE	AP010	Solder	Clamp	Figure 1
13-014-B3-HB	RG402 (.141")	50	HB	AP033	Solder	Solder	Figure 2 Direct Solder for Semi-Rigid Cable

For full details of assembly procedures, go to [www.coax-connectors.com/ap](http://www.coax-connectors.com/ap)

For full details of assembly procedures, go to [www.coax-connectors.com/ap](http://www.coax-connectors.com/ap)  
 \*4 Part connectors include an insulated sleeve to provide additional support for small cables during assembly  
 \*\*Soldering of the centre conductor is recommended for optimum performance (AP004)

Figure 1

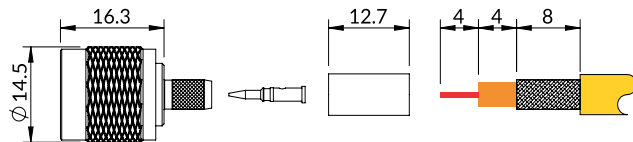

Figure 2

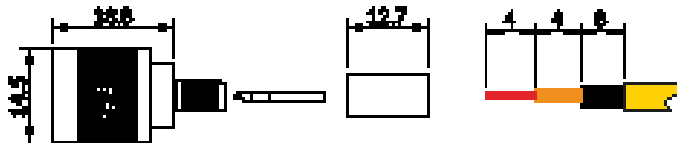

Figure 1

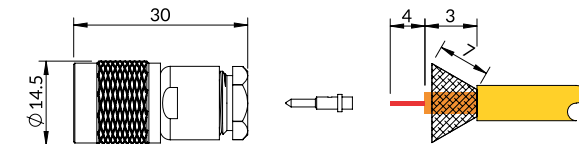
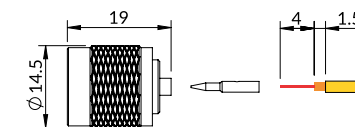

Figure 2



## Right angle plug crimp & solder.

Figure 1

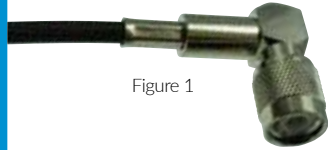
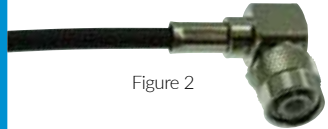

Figure 2



TNC right angle plugs have either crimp or soldered gold plated contacts and crimped outer conductor. Crimped contacts are 2 part, where the crimped portion mates with fixed element during assembly to provide improved RF performance.

Crimp sizes are shown in the table and suitable tooling can be found in the Accessories & Tooling section of this catalogue.

Part Number	Cable Types (for more see appendix)	$\Omega$	Cable Group	Assembly Procedure	Centre Contact	Outer Contact	Features
13-104-A3-AH	RG58, RG141, Times LMR®195	50	AH	AP019	1.72 Hex	5.41 Hex	Figure 1
13-104-A3-AK	RG223	50	AK	AP019	1.72 Hex	6.5 Hex	Figure 1
13-106-A0-AD	See appendix for details on pages 198-203	50	AD	AP002	1.72 Hex	5.41 Hex	Figure 1 4 Part *
13-105-B3-AK	RG223	50	AK	AP017	Solder	6.5 Hex	Figure 2
13-105-B3-AN	RG213, URM67, KX4	50	AN	AP017	Solder	10.9 Hex	Figure 2
13-105-B3-DC	Times LMR®300	50	DC	AP017	Solder	5.41 Hex	Figure 2
13-105-B3-DE	See appendix for details on pages 198-203	50	DE	AP017	3.25 Hex	10.9 Hex	Figure 2 ** See Notes

For full details of assembly procedures, go to [www.coax-connectors.com/ap](http://www.coax-connectors.com/ap)  
 \*Items marked '4 Part' are for small cables and include a supporting sleeve for reliable assembly.  
 \*\* Soldering of the centre conductor is recommended for optimum performance

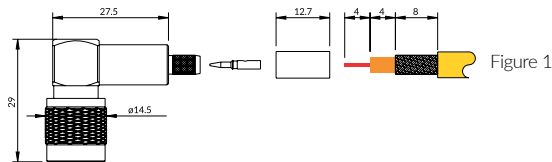

Figure 1

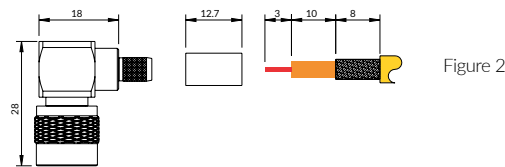

Figure 2

## Straight crimp jack.

TNC cable jacks have either crimp or soldered gold plated contacts and crimped outer conductor. Body parts are nickel plated.

Crimp sizes are shown in the table and suitable tooling can be found in the Accessories & Tooling section of this catalogue.

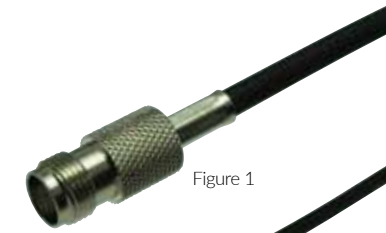

Figure 1



Figure 2

Part Number	Cable Types (for more see appendix)	$\Omega$	Cable Group	Assembly Procedure	Centre Contact	Outer Contact	Features
13-054-A3-AH	RG58, RG141 Times LMR®195	50	AH	AP001	1.72 Hex	5.41 Hex	Figure 1
13-054-A3-AK	RG223	50	AK	AP001	1.72 Hex	6.5 Hex	Figure 1
13-054-B3-DB	Times LMR®240, Belden 155	50	DB	AP001	1.72 Hex	5.41 Hex	Figure 1 **
13-054-B3-DE	See appendix for details on pages 198-203	50	DE	AP004/ AP001	3.25 Hex	10.9 Hex	Figure 1 **
13-055-A3-AB	RG179, RG187 Belden 179DT	75	AB	AP002	1.72 Hex	5.41 Hex	Figure 2 4 Part *
13-055-A3-AD	RG174, RG188, RG316 Times LMR®100	50	AD	AP002	1.72 Hex	5.41 Hex	Figure 2 4 Part *

For full details of assembly procedures, go to [www.coax-connectors.com/ap](http://www.coax-connectors.com/ap)  
 \*Items marked '4 Part' are for small cables and include a supporting sleeve for reliable assembly.  
 \*\* Soldering of the centre conductor is recommended for optimum performance (AP004)

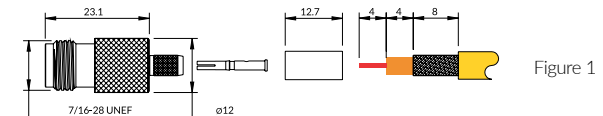

Figure 1

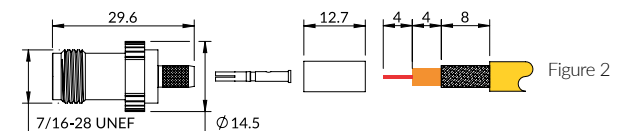

Figure 2

## Straight rear mount bulkhead cable jack.

TNC bulkhead cable jacks are available in either insulated or non-insulated versions to suit the range of cables indicated below.

See table below for crimp sizes, suitable tooling can be found in the Accessories & Tooling section of this catalogue.

All bulkhead mounted variants are fitted with a sealing ring giving IP64 protection against the panel, and include a nut and lock washer.



Figure 1



Figure 2

Part Number	Cable Types (for more see appendix)	$\Omega$	Cable Group	Assembly Procedure	Centre Contact	Outer Contact	Features
13-254-A3-AH	RG58, RG141 Times LMR@195	50	AH	AP001	1.72 Hex	5.41 Hex	Figure 1
13-254-B3-AK	RG223	50	AK	AP001	1.72 Hex	6.5 Hex	Figure 1
13-254-B3-DB	Times LMR@240, Belden 155	50	DB	AP001	1.72 Hex	5.41 Hex	Figure 1
13-256-A0-AA	RG178, RG196	50	AA	AP002	1.72 Hex	5.41 Hex	Figure 1, 4 Part *
13-256-A0-AD	RG174, RG188, RG316 Times LMR@100	50	AD	AP002	1.72 Hex	5.41 Hex	Figure 1, 4 Part *
13-258-A3-AH	RG58, RG141, Times LMR@195	50	AH	AP001	1.72 Hex	5.41 Hex	Figure 2 Insulated
13-264-A0-AD	RG174, RG188, RG316 Times LMR@100	50	AD	AP002	1.72 Hex	5.41 Hex	Figure 1, 4 Part * Bullet contact
13-264-B3-AA	RG178, RG196	50	AA	AP002	1.07 Sq	3.25 Hex	Figure 1, 4 Part * Bullet contact
13-260-A5-AB	RG179, RG187 Belden179DT	75	AB	AP001	1.72 Hex	5.41 Hex	Figure 2, 4 Part * Insulated

For full details of assembly procedures, go to [www.coax-connectors.com/ap](http://www.coax-connectors.com/ap)  
 \*Items marked '4 Part' are for small cables and include a supporting sleeve for reliable assembly.

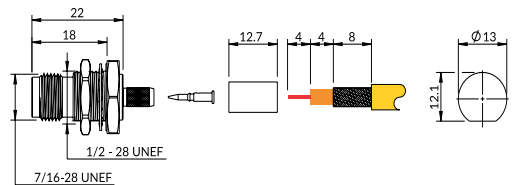

Figure 1

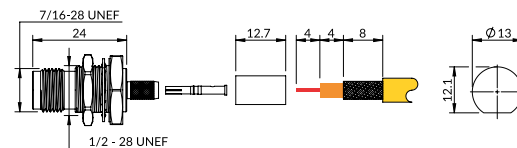

Figure 2

## Straight front mount bulkhead solder jack.

TNC bulkhead cable plugs are available in either insulated or non-insulated versions to suit the range of cables indicated below.

See table below for crimp sizes, suitable tooling can be found in the Accessories & Tooling section of this catalogue.

These bulkhead mounted variants are fitted with a sealing ring giving IP64 protection against the panel, and include a nut and lock washer.



Part Number	$\Omega$	Drawing dimension			Centre Contact	Features
		A	B	C		
13-350-A3	50	12	6	16	Solder	Single flat
13-355-A3	50	12	6	16	Solder	Double D Flat

Figure 1

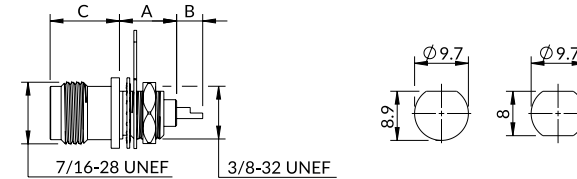

## Flange mount plug.

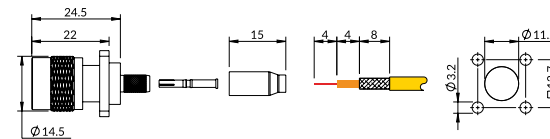

Part Number	$\Omega$	Cable Types	Cable Group	Assembly Procedure	Centre Contact	Outer Contact	Features
13-322-B3-AD	50	See appendix for details on pages 198-203	AD	AP001	1.72 Hex	5.41 Hex	

For full details of assembly procedures, go to [www.coax-connectors.com/ap](http://www.coax-connectors.com/ap)



## Flange mount jack.

Flange mount jacks are available for either flexible or Semi-Rigid cable. Options with a flange seal are available.

The flexible cable version is assembled using full crimp methods whilst those for semi-rigid cable are soldered.

Centre contact is gold plated, the body is nickel plated.

Crimp sizes are shown in the table and suitable assembly tooling can be found in the Accessories & Tooling section of this catalogue.

Part Number	Cable Types (for more see appendix)	$\Omega$	Cable Group	Assembly Procedure	Centre Contact	Outer Contact	Features
13-278-A3-AD	RG174, RG188, RG316, Times LMR®100	50	AD	AP001	1.72 Hex	5.41 Hex	Figure 1
13-279-B3-HA-17.5mm	RG405(0.085")	50	HA	AP033	Solder	Solder	Figure 2 Direct solder to Semi-Rigid
13-283-B3-HA-17.5mm	RG405(0.085")	50	HA	AP033	Solder	Solder	Figure 2 With panel seal. Direct solder to Semi-Rigid

For full details of assembly procedures, go to [www.coax-connectors.com/ap](http://www.coax-connectors.com/ap)

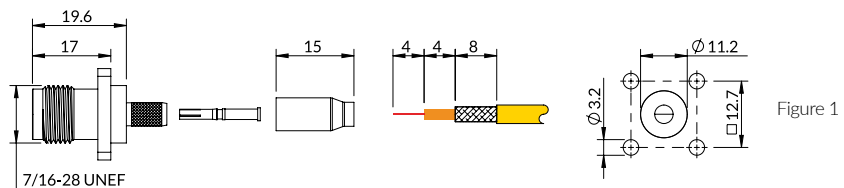

Figure 1

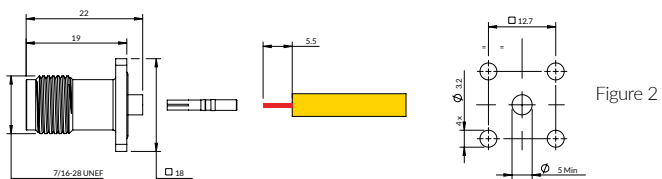
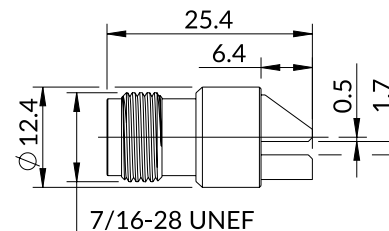

Figure 2

## End launch PCB jack.

Edge mounted PCB jack for soldering to a 1.6mm nominal thickness PCB.

Centre contact is gold plated, the body is white bronze plated.



Part Number	$\Omega$	Features
13-410-1.57mm-Q3	50	1.6mm board thickness, White Bronze finish

## Right angle PCB bulkhead jack.

Fitted with gold plated centre contact, the other body parts are nickel plated.

A sealing ring provides IP64 protection when mounted against a suitable panel. Supplied complete with nut and lock washer.



Part Number	$\Omega$	Features
13-468-B3	50	IP64 bulkhead seal

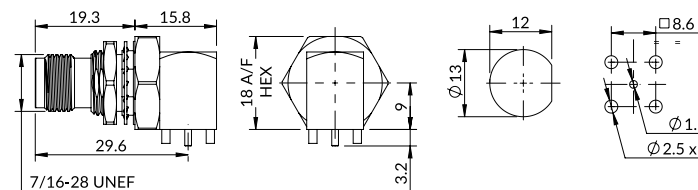

# Adaptors.

Adaptors in a range of configurations for connection within the TNC series. For connecting TNC to other coaxial connector types, see our range of Inter Series Adaptors.

All adaptors have gold plated centre contacts with nickel plated bodies.

Part Number	$\Omega$	Figure	Description	Interface Arrangement		Features
				Left	Right	
13-500-A3	50	Fig. 1	Straight adaptor	Jack	Jack	
13-500-B36	75	Fig. 1	Straight adaptor	Jack	Jack	3GHz
13-501-A3	50	Fig. 2	Straight bulkhead adaptor	Jack	Jack	
13-503-B126	75	Fig. 3	Insulated straight bulkhead adaptor	Jack	Jack	12GHz
13-514-A3	50	Fig. 4	Straight adaptor	Plug	Plug	
13-520-A3	50	Fig. 5	Right angle adaptor	Plug	Jack	
13-520-1-Y3	50	Fig. 6	Right angle long adaptor	Plug	Jack	Black non reflective nickel

Figure 1

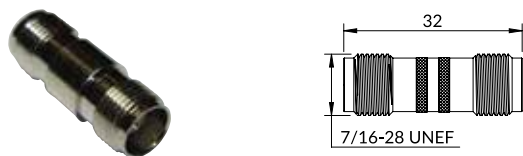

Figure 2

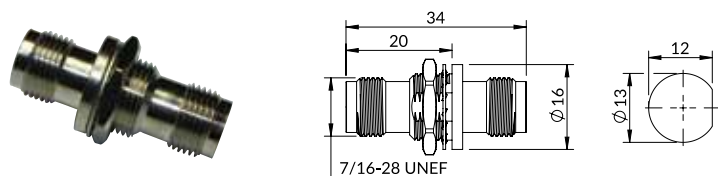

Figure 3

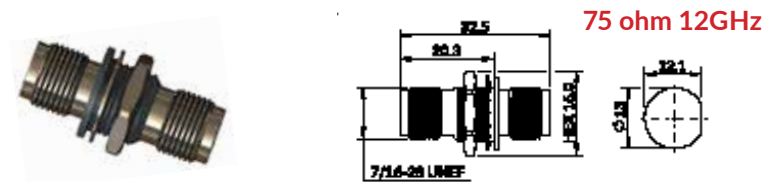

Figure 4

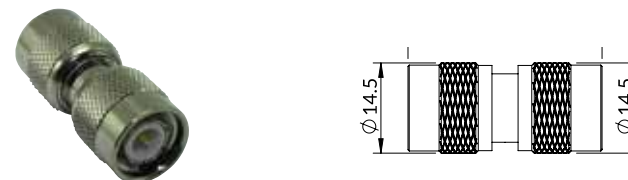
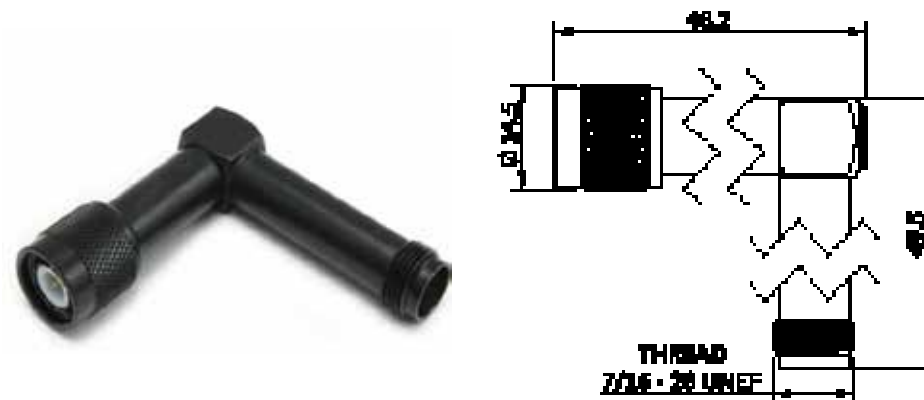

Figure 5



Figure 6







## TNC 50 ohm reverse polarity.

In common with standard TNC connectors, the reverse polarity versions featured in this section are a screw lock coupling version of the BNC connectors. The screw coupling enables TNC to be used at frequencies up to 11GHz in harsh environment situations.

Widely used for antenna connections, TNC have many applications in avionics, defence, communications and general industrial markets. Reverse polarity TNC connectors are used where some form of differentiation from standard versions of TNC is required to avoid connection to the wrong line.

### Key features:

- Reverse polarity
- Wide range of cables covered
- Cable assemblies on request

### TNC reverse polarity interface.

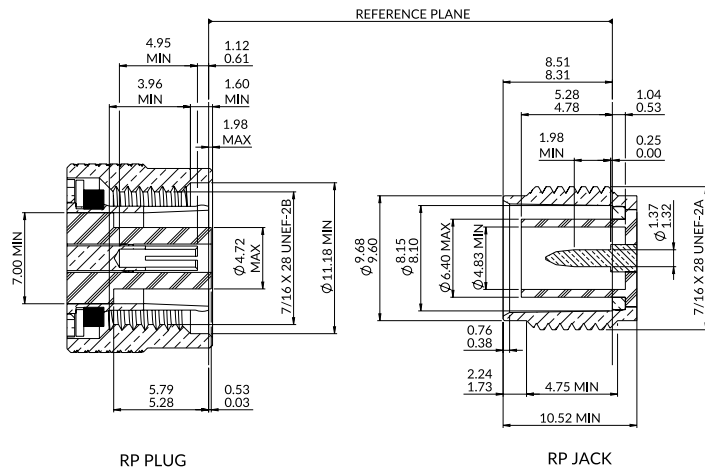

### RP straight crimp plug.

TNC Reverse Polarity 50 ohm plugs are identical to standard TNC plugs except that the interface polarity is reversed. R/P connectors are ideal where 2 lines are mounted on the same panel and it is important to ensure that they can not be incorrectly mated.

Crimp sizes are shown in the table, further information on tooling can be found in the Accessories & Tooling section of this catalogue.



Part Number	Cable Types	Cable Group	Assembly Procedure	Centre Contact	Outer Contact	Features
14-005-A3-AH	RG58, RG141, Times LMR@195	AH	AP001	1.72 Hex	5.41 Hex	
14-005-A3-AK	RG223	AK	AP001	1.72 Hex	6.5 Hex	
14-005-B3-DE	Times LMR@400 RG8, 9913	DE	AP004/ AP001	2.54 Hex	10.9 Hex	** See Notes
14-006-A3-AD	RG174, RG188, RG316 Times LMR@100	AD	AP002	1.72 Hex	5.41 Hex	* 4 Part

For full details of assembly procedures, go to [www.coax-connectors.com/ap](http://www.coax-connectors.com/ap)  
 \*Items marked '4 Part' are for small cables and include a supporting sleeve for reliable assembly.  
 \*\*Soldering of the centre conductor is recommended for optimum performance (AP004)

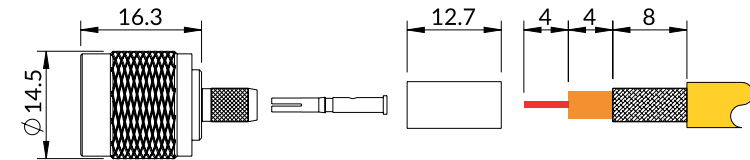

## RP straight crimp jack.

TNC Reverse Polarity 50 ohm jacks are identical to standard TNC jacks except that the interface polarity is reversed. R/P connectors are ideal where 2 lines are mounted on the same panel and it is important to ensure that they can not be incorrectly mated.

Crimp sizes are shown in the table, further information on tooling can be found in the Accessories & Tooling section of this catalogue.



Part Number	Cable Types (for more see appendix)	Cable Group	Assembly Procedure	Centre Contact	Outer Contact	Features
14-054-A3-AH	RG58, RG141, Times LMR®195	AH	AP001	1.72 Hex	5.41 Hex	
14-054-A3-AK	RG223	AK	AP001	1.72 Hex	6.5 Hex	
14-054-A3-AN	RG213, URM67, KX4	AN	AP001	2.54 Hex	10.9 Hex	
14-054-B3-DE	Times LMR®400, RG8, 9913	DE	AP001	2.54 Hex	10.9 Hex	** See Notes
14-055-A3-AD	See appendix for details on pages 198-203	AD	AP002	1.72 Hex	5.41 Hex	* 4 Part

For full details of assembly procedures, go to [www.coax-connectors.com/ap](http://www.coax-connectors.com/ap)  
 \* Items marked '4 Part' are for small cables and include a supporting sleeve for reliable assembly.  
 \*\*Soldering of the centre conductor is recommended for optimum performance (AP004)

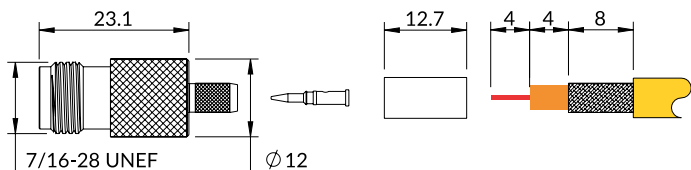

## RP straight bulkhead jack.

TNC Reverse Polarity 50 ohm jacks are identical to standard TNC jacks except that the interface polarity is reversed. R/P connectors are ideal where 2 lines are mounted on the same panel and it is important to ensure that they can not be incorrectly mated.

Crimp sizes needed to assemble these connectors are shown in the table, further information on tooling can be found in the Accessories & Tooling section of this catalogue.



Part Number	Cable Types (for more see appendix)	Cable Group	Assembly Procedure	Centre Contact	Outer Contact	Features
14-254-A3-AH	RG58, RG141, Times LMR®195	AH	AP001	1.72 Hex	5.41 Hex	
14-254-A3-AK	RG223	AK	AP001	1.72 Hex	6.5 Hex	
14-256-A3-AD	See appendix for details on pages 198-203	AD	AP002	1.72 Hex	5.41 Hex	4 part*

For full details of assembly procedures, go to [www.coax-connectors.com/ap](http://www.coax-connectors.com/ap)  
 \*Items marked '4 Part' are for small cables and include a supporting sleeve for reliable assembly.

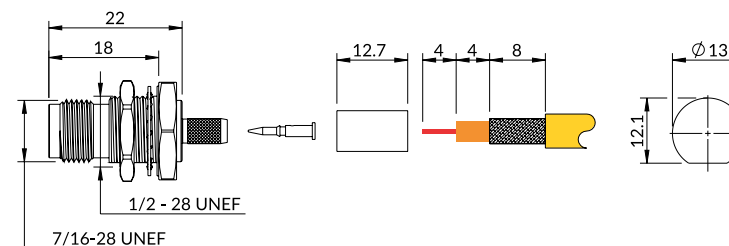



F Type	Page
Cable plug - single piece with integral crimp	82
Adaptors	82
Cable plug - Other	83

## F Type connectors.

F Type are low cost 50 & 75 ohm miniature connectors typically used in cable TV, satellite TV, CATV and cable modem installations. F type have a screw coupling and commonly use the solid centre conductor of the cable as the centre contact although versions with a separate crimped contact are available.

Body parts are nickel plated and where applicable the centre contacts are gold plated.

### Key Features:

- Simple assembly
- Low cost
- Single part on certain styles



### New connectors.

We are regularly designing new connectors to enhance our range, if you can not find what you need, please contact us.

## Specification.

Electrical Specification		Environmental Specification	
Impedance	75 ohm	Operation temperature	-40 to +140 Deg C
Frequency Range	Up to 3GHz	IP Rating (Mated)	IP64
Dielectric Withstand Voltage	1500 Veff		
Insulation Resistance	1000 M-ohm		
Mechanical Specification		Materials	
Design Standard	IEC 60169-24	Centre Contact	Brass/Phosphor Bronze
ROHS Compliant	Yes	Outer Contact	Brass
Mating Cycles	100	Insulator	PTFE
Contact Retention	20N max	Coupling Nut	Brass
Coupling Nut Torque	0.46 - 0.69Nm	Centre Contact Plating	Gold
		Outer Contact Plating	Nickel/Gold

The above values are typical. Please check product data sheets for full details - see [www.coax-connectors.com](http://www.coax-connectors.com) or call +44(0)20 8538 9090

## F Type interface.

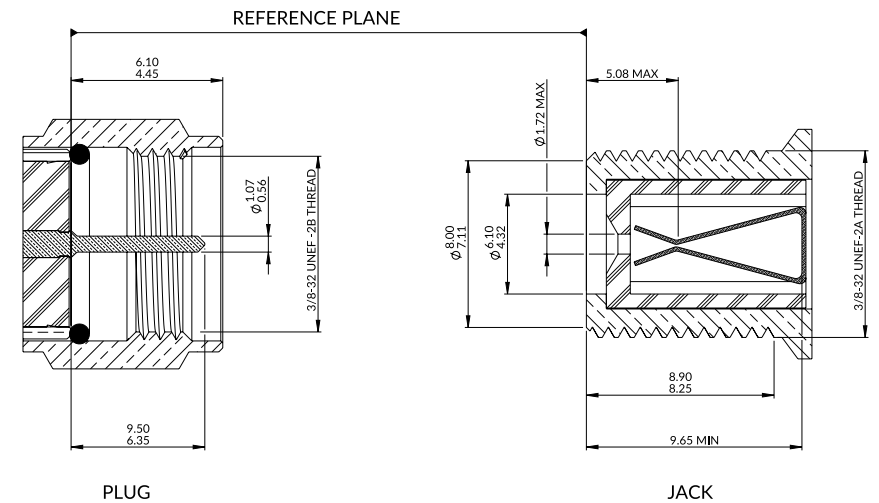

## Cable plug - single piece - integral crimp.

F Type plugs with integral crimp are a single part connector where the crimp sleeve is formed from the main body and the centre conductor of the cable acts as the centre contact.

The threaded nut provides a secure coupling to the mating half to prevent accidental disconnection. All elements of this connector are nickel plated.

Part Number	Typical Cable Types (For more see appendix)	Cable Group	Assembly Procedure	Centre Contact	Outer Contact	Features
15-015-Z0-AI	RG59, RG62, URM70	AI	AP009	N/A	8.23 Hex	
15-015-Z0-AN	RG213, URM67, KX4	AN	AP009	N/A	10.9 Hex	
15-015-Z0-AS Bulk	RG7	AS	AP009			
15-015-Z0-CA	CT100, RG6, WSC100	CA	AP009	N/A	8.05 Hex	
15-015-Z0-CC	CT125	CC	AP009	N/A	11.4 Hex	
15-015-Z0-CE	CT167	CE	AP009	N/A		
15-024-Z0-CC	CT125	CC	AP009	N/A	8.6 Hex	Non-standard crimp size

For full details of assembly procedures, go to [www.coax-connectors.com/ap](http://www.coax-connectors.com/ap)

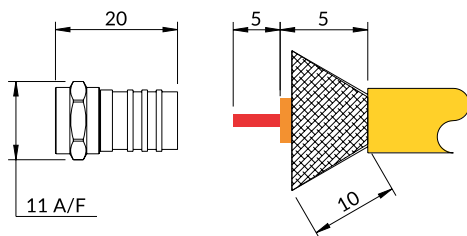

## Adaptors.

Adaptors for connecting together F Type connectors. For connecting F Type to other series, see our range of Inter-Series Adaptors.



Figure 1

Part Number	Configuration	Features
15-501-A0	Jack to jack - bulkhead fixing	Figure 1
15-514-A6	Plug to plug	Figure 2

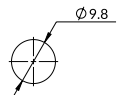
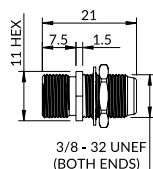

Figure 1

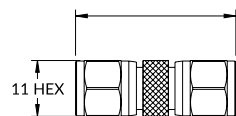

Figure 2

## Cable plug - up to 3GHz.

For higher RF performance these full crimp versions feature separate gold plated centre contact which provides a more robust and reliable connector. Selected versions are suitable for use up to 3GHz, see table below.

Standard plugs include a slip ring to allow for finger tightening. The items 15-005-B36-1-xx do not have a slip ring fitted to allow for spanner tightening.

Also available are the simple to assemble variants using Twist-On and the tool-less Spring-Lock termination.



Part Number	Typical Cable Types (For more see appendix)	Cable Group	Assembly Procedure	Centre Contact	Outer Contact	Features
15-005-A6-AB	RG179, RG187, Belden179DT	AB	AP001	1.07 Sq	3.25 Hex	
15-005-B36-AB	RG179, RG187, Belden179DT	AB	AP001	0.95 Sq	3.25 Hex	Figure 1, 3GHz
15-005-B36-FA		FA	AP001	1.72 Hex	5.41 Hex	Figure 1, 3GHz
15-005-B36-1-FA	See appendix for details on pages 198-203	FA	AP001	1.72 Hex	5.41 Hex	Figure 2, 3GHz No slip ring fitted
15-005-B36-FB		FB	AP001	1.72 Hex	6.50 Hex	Figure 1, 3GHz
15-005-B36-FC		FC	AP001	1.72 Hex	8.23 Hex	Figure 1, 3GHz
15-005-B36-FE	Belden 1505F, Bryant SD50F	FE	AP001	1.72 Hex	6.50 Hex	Figure 1, 3GHz
15-005-B36-1-FE	Belden 1505F, Bryant SD50F	FE	AP001	1.72 Hex	6.50 Hex	Figure 2, 3GHz No slip ring fitted
15-005-B36-FG	CM2231, CM3641	FG	AP001	1.72 Hex	6.48 Hex	Figure 1, 3GHz
15-027-Z0-CA	CT100, RG6, WSC100	CA	AP001	1.72 Hex	8.05 Hex	Figure 1
15-004-Z0-AG	Mini RG59 White	AG	AP001	N/A	5.41 Hex	Twist-on, not illustrated
15-026-D6-CA	CT100, RG6, WSC100	CA	AP008	Push-On	Push-On	Spring-Lock, not illustrated

For full details of assembly procedures, go to [www.coax-connectors.com/ap](http://www.coax-connectors.com/ap)

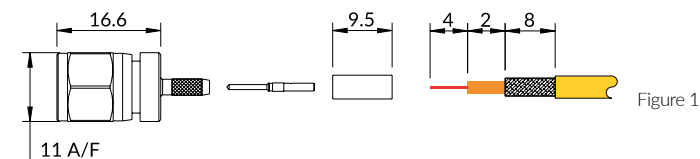

Figure 1

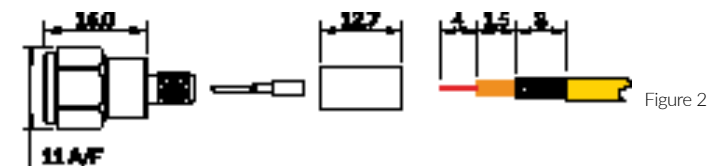

Figure 2

## Euro TV connector.

These connectors are used as the main antenna connection for TV sets in Europe. Designed to meet the IEC61169-2 specification, these connectors fit to standard 75 ohm cables, such as the popular RG59 or similar.

In addition to the cable plug, a jack to jack adaptor is available for extending cables or changing the interface.



Figure 1



Figure 2

Part Number	Cable Types (for more see appendix)	Cable Group	Centre Contact	Outer Contact	Features
16-020-A0-AI	RG59, RG62, URM70	AI	Screw	Screw-On	Figure 1
16-020-A0-CA	CT100, RG6, WSC100	CD	Screw	Screw-On	Figure 1
16-500-A0	N/A		Jack to Jack adaptor		Figure 2

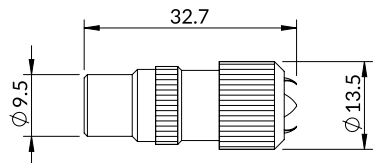

Figure 1

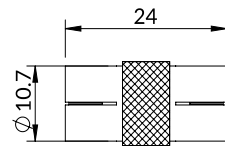

Figure 2

# Tooling

See page 194



0.4/2.5 - 75 ohm	Page
Surface mount PCB plug and jack	86
Cable plug and jack	87

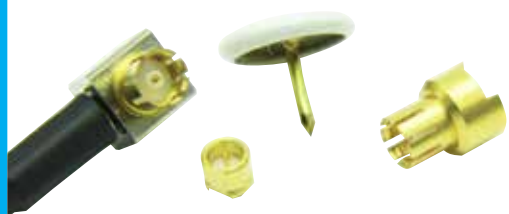

# 0.4/2.5 Connectors.

0.4/2.5 is one of the smallest True 75 ohm connectors available.

This micro-miniature series is ideal for High Definition camera and CCTV applications or anywhere a very small 75 ohm board connection is required. Suitable for use up to 4.5 GHz, this series exceeds the requirements of SMPTE 292M and HD-SDI standards for HD broadcasts.

The range includes surface mounted plugs and jacks together with a selection of cable connectors.

When used in a parallel board to board configuration, only 8mm between boards is required. When the board mounted plug is mated with a right angle cable jack, only 10mm height above board is needed.

## Surface mount PCB plug and jack.



Figure 1

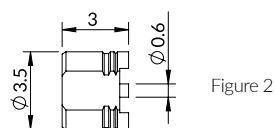
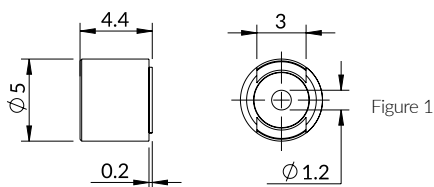

Figure 2

With a plug height of only 3mm above board, these PCB connectors are designed for surface mount soldering and feature an orientation flat on the body for pick and place assembly. Connectors can be supplied in tape and reel or loose packed.

With gold plated inner and outer contacts, these high performance micro miniature connectors are ideal for use in equipment packages where space is critical.

Part Number	Description	Figure
18-483-D6	Straight PCB Jack - Surface mount assembly	Figure 1
18-403-D6	Straight PCB Plug - Surface mount assembly	Figure 2



## Cable plug and jack.

A selection of cable connectors includes straight and right angle options. Designed for use with RG179 size cables, connectors to fit other miniature 75 ohm cables types are available on request.

Centre contacts of the straight versions are indent crimped and right angle versions are soldered with the outer conductor being terminated with a hexagon crimp.

Full details of suitable tooling can be found in the Accessories & Tooling section of this catalogue.

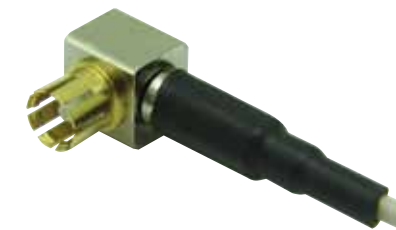

Part Number	Typical Cable Types (for more see appendix)	Cable Group	Assembly Procedure	Centre Contact	Outer Contact	Features
18-005-D36-AB	RG179, RG187, 179DT	AB	AP023	Indent Crimp	3.25 Hex	Figure 1 Straight Plug
18-054-D36-AB	RG179, RG187, 179DT	AB	AP023	Indent Crimp	3.25 Hex	Figure 2 Straight Jack
18-154-D6-AB	RG179, RG187, 179DT	AB	AP017	Solder	3.25 Hex	Figure 3 Right Angle Jack

For full details of assembly procedures, go to [www.coax-connectors.com/ap](http://www.coax-connectors.com/ap)

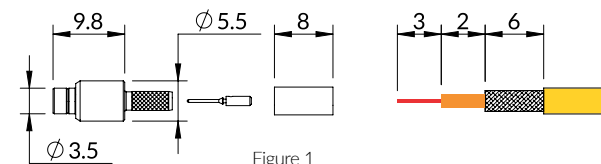

Figure 1

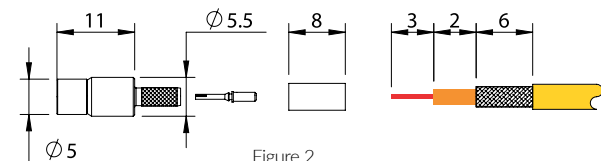

Figure 2

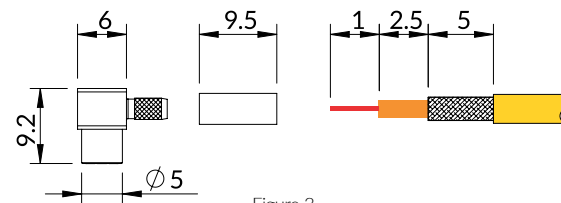

Figure 3





## UHF connectors.

UHF are a range of 50 ohm connectors for low frequency RF applications.

UHF are typically used in amateur radio, CB radio and VHF, they have a screw (5/8 x 24UNEF) coupling and are suitable for use up to 300MHz.

The cable plug is also known as PL259.

## Specification.

Electrical Specification		Environmental Specification	
Impedance	50 ohm	Operation temperature	-25 to +70 Deg C
Frequency Range	Up to 300MHz	IP Rating (Mated)	IP64
Dielectric Withstand Voltage	750 Veff		
Insulation Resistance	5000 M-ohm		
Mechanical Specification		Materials	
Design Standard	IEC-60169-12	Centre Contact	Brass/Phosphor Bronze
ROHS Compliant	Yes	Outer Contact	Brass
Mating Cycles	500	Insulator	PTFE
Contact Retention	30N min	Coupling Nut	Brass
		Centre Contact Plating	Gold
		Outer Contact Plating	Nickel

The above values are typical. Please check product data sheets for full details - see [www.coax-connectors.com](http://www.coax-connectors.com) or call +44(0)20 8538 9090

## UHF interface.

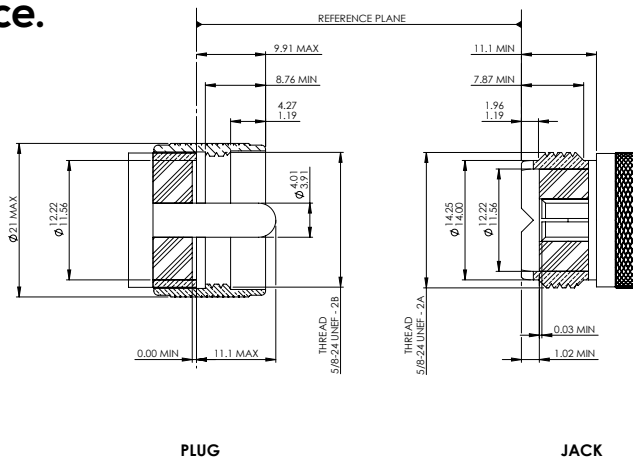

PLUG

JACK

## Straight cable plug (PL259).

UHF straight cable plugs, often referred to as PL259 are available either for full crimp or Twist-On termination.

Twist-On styles do not require special tooling to assemble onto cable, the prepared cable is simply screwed into the rear body of the connector and the centre conductor is soldered through the contact end.

Where required, suitable crimp tooling can be found in the Accessories & Tooling section of this catalogue.



Figure 1

Figure 2

Part Number	Cable Types (for more see appendix)	$\Omega$	Cable Group	Assembly Procedure	Centre Contact	Outer Contact	Features
20-005-A0-AD	RG174, RG188, RG316, Times LMR®100	50	AD	AP001	1.72 Hex	5.41 Hex	Figure 1
20-005-A0-AH	RG58, RG141, Times LMR®195	50	AH	AP001	1.72 Hex	5.41 Hex	Figure 1
20-016-A0-AN	RG213, URM67, KX4	50	AN	AP001	Solder	Twist-On	Figure 2
20-016-A0-AO	RG214	50	AO	AP001	Solder	Twist-On	Figure 2
20-016-K0-AH	RG58, RG141, Times LMR®195	50	AH	AP001	Solder	Twist-On	
20-016-K1-AH	RG58, RG141, Times LMR®195	50	AH	AP001	Solder	Twist-On	

For full details of assembly procedures, go to [www.coax-connectors.com/ap](http://www.coax-connectors.com/ap)

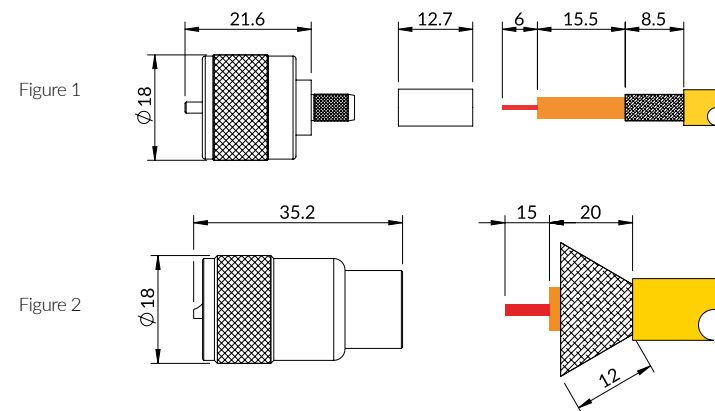

Figure 1

Figure 2



## Right angle cable plug.

This right angle UHF plug requires no special tooling to assemble to cable. The prepared cable is simply soldered to the centre contact and the jacket and braid are clamped.

Part Number	Cable Types (for more see appendix)	$\Omega$	Cable Group	Centre Contact	Outer Contact	Features
20-100-A3-AH	RG58,RG141,Times LMR®195	50	AH	Solder	Clamp	

For full details of assembly procedures, go to [www.coax-connectors.com/ap](http://www.coax-connectors.com/ap)

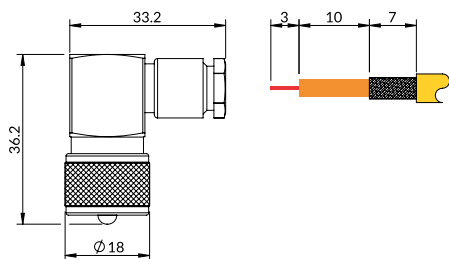

## Cable jack.

UHF cable jacks require no special tooling to terminate to cable. The centre conductor is simply soldered to the contact and the braid and jacket are clamped.

Part Number	Cable Types	Assembly Procedure	Cable Group	Centre Contact	Outer Contact	Features
20-050-G0-AH	RG58,RG141,Times LMR®195	AP001	AH	Solder	Clamp	

For full details of assembly procedures, go to [www.coax-connectors.com/ap](http://www.coax-connectors.com/ap)

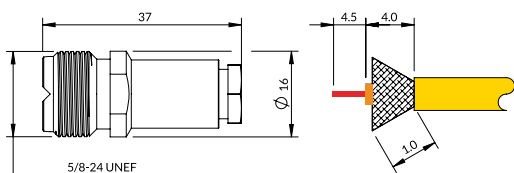

## Adaptors.

Part Number	Configuration	$\Omega$	Features
20-500-A0	Jack to Jack	50	Figure 1
20-501-A0	Jack to Jack - Bulkhead mount	50	Figure 2

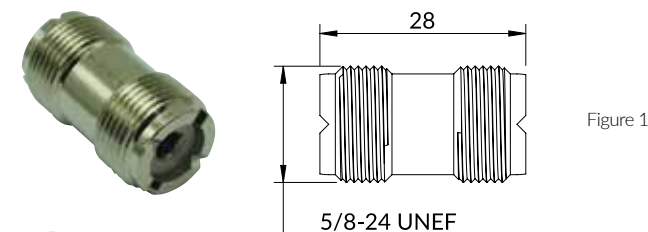

Figure 1

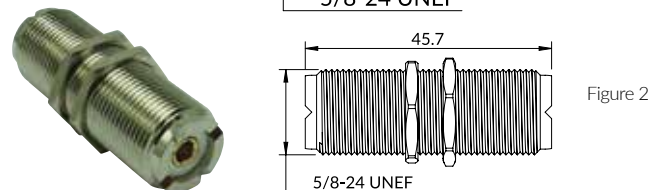

Figure 2

## Mini UHF cable plug.

Mini UHF is a smaller version of the standard UHF and is used in similar communication applications.

This plug is assembled by crimping both the centre and outer conductors.

Crimp sizes are shown in the table, suitable crimp tooling can be found in the Accessories & Tooling section of this catalogue



Part Number	Cable Types	$\Omega$	Cable Group	Assembly Procedure	Centre Contact	Outer Contact	Features
21-005-A3-AH	RG58,RG141,Times LMR®195	50	AH	AP001	1.72 Hex	5.41 Hex	

For full details of assembly procedures, go to [www.coax-connectors.com/ap](http://www.coax-connectors.com/ap)

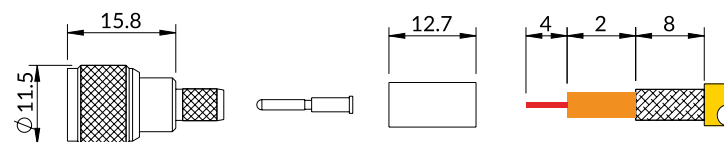



## FME connectors.

FME are a 50 ohm series designed for connecting communications equipment in automotive applications typically up to 2GHz. FME feature a robust screw coupling and are crimped to cable using industry standard methods.

Body parts are nickel plated and the centre contacts are gold plated.

Crimp sizes are shown in the tables and suitable tooling can be found in the Accessories & Tooling section of this catalogue.

## Specification.

Electrical Specification		Environmental Specification	
Impedance	50 ohm	Operation temperature	-55 to +155 Deg C
Frequency Range	Up to 2GHz	IP Rating (Mated)	IP30
Dielectric Withstand Voltage	500 Veff		
Insulation Resistance	5000 M-ohm		
Mechanical Specification		Materials	
ROHS Compliant	Yes	Centre Contact	Brass/Phosphor Bronze
Mating Cycles	250	Outer Contact	Brass
Coupling Nut Torque	<2Nm	Insulator	PTFE
		Coupling Nut	Brass
		Centre Contact Plating	Gold
		Outer Contact Plating	Nickel

The above values are typical. Please check product data sheets for full details - see [www.coax-connectors.com](http://www.coax-connectors.com) or call +44(0)20 8538 9090

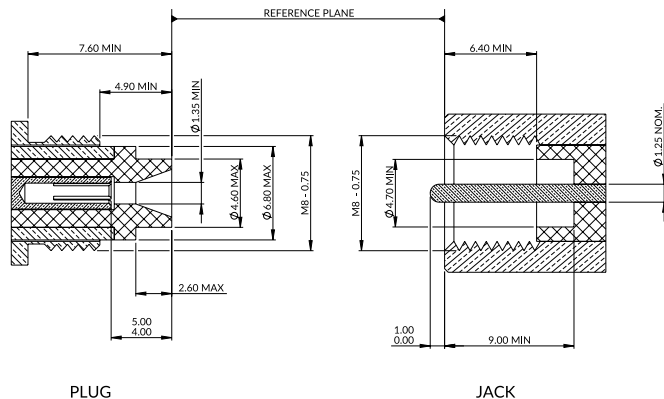

## Straight cable plug.

FME cable plug has a nickel plated body and the centre contact is gold plated.

Centre and outer conductors are crimped. Crimp sizes are shown in the table and suitable tooling can be found in the Accessories & Tooling section of this catalogue.



Part Number	Cable Types (for more see appendix)	Cable Group	Assembly Procedure	Centre Contact	Outer Contact	Features
22-005-A3-AD	See appendix for details on pages 198-203	AD	AP001	1.07 Sq	3.25 Hex	
22-005-A3-AH	RG58, RG141, Times LMR@195	AH	AP001	1.72 Hex	5.41 Hex	
22-005-A3-AK	RG223	AK	AP001	1.72 Hex	6.5 Hex	
22-007-A0-AA	RG178, RG196	AA	AP036	1.07 Sq	3.25 Hex	5 part

For full details of assembly procedures, go to [www.coax-connectors.com/ap](http://www.coax-connectors.com/ap)

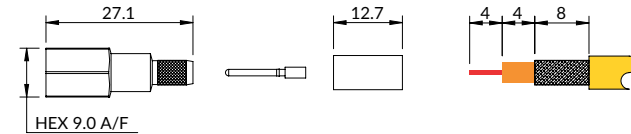

## Straight cable jack.

FME cable jack has a nickel plated body and the centre contact is gold plated.

Centre and outer conductors are crimped. Crimp sizes are shown in the table and suitable tooling can be found in the Accessories & Tooling section of this catalogue.



Part Number	Cable Types (for more see appendix)	Cable Group	Assembly Procedure	Centre Contact	Outer Contact	Features
22-054-A0-AK	RG223	AK	AP001	1.72 Hex	6.5 Hex	
22-054-A3-AA	RG178, RG196	AA	AP001	1.07 Sq	3.25 Hex	
22-054-A3-AD	See appendix for details	AD	AP001	1.07 Sq	3.25 Hex	
22-054-A3-AH	RG58, RG141, Times LMR@195	AH	AP001	1.72 Hex	5.41 Hex	

For full details of assembly procedures, go to [www.coax-connectors.com/ap](http://www.coax-connectors.com/ap)

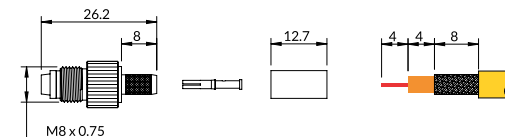



## Bulkhead cable plug.

FME bulkhead mount cable plug is supplied complete with fixing nut and lock washer. The body parts are nickel plated and the centre contact gold plated.

Centre and outer conductors are crimped. Crimp sizes are shown in the table and suitable tooling can be found in the Accessories & Tooling section of this catalogue.

Part Number	Cable Types (for more see appendix)	Cable Group	Assembly Procedure	Centre Contact	Outer Contact	Features
22-204-A3-AD	See appendix for details on pages 198-203	AD	AP001	1.07 Sq	3.25 Hex	Bulkhead Mount

For full details of assembly procedures, go to [www.coax-connectors.com/ap](http://www.coax-connectors.com/ap)

## Adaptors.



Figure 1

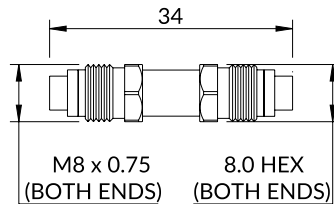
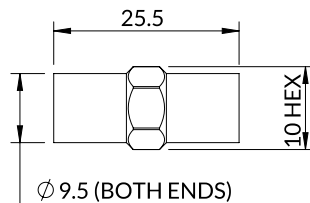

Figure 2



Part Number	Configuration	Comments
22-500-A3	Jack to jack	Figure 1
22-514-A0	Plug to plug	Figure 2

# Bespoke cable assemblies

See page 6





# N Type connectors.

N Type connectors are available in 50 & 75 ohm versions with certain 50 ohm styles being suitable for use up to 18GHz.

With a rugged screw coupling, N Type are a mid sized series of RF connectors with the interface designed according to IEC61169-16 and are sealed to IP67 when mated.

N Type connectors are widely used in communication systems where higher performance and power are required.

Note - 50 and 75 ohm versions of N Type connectors are not compatible and permanent damage to the connector may occur if mated.

## Key Features:

- 50 & 75 ohm options
- Rugged Screw Coupling
- Up to 18GHz for selected styles
- IP67 when mated



N Type 50 & 75 ohm	Page
Straight cable plug for flexible cable	98
Straight direct solder cable plug for Semi-Rigid cables	99
Straight solder / clamp cable plug	100
Straight Easy-Fit cable plug	101
Right angle cable plugs	102
Bulkhead mount plug	103
Straight crimp cable jack	104
Straight clamp & Easy-Fit cable jack	105
Straight bulkhead rear mount cable jack.	106
Straight flange mount cable jack, crimp & direct solder	107
Front mount bulkhead jack	108
Bulkhead 4 hole flange mount jack	108
Dust cap & shorting cap	109
Adaptors	110-111

## Specification.

The values below are typical. Please check product data sheets for full details - see [www.coax-connectors.com](http://www.coax-connectors.com) or call +44(0)20 8538 9090

Electrical Specification		Environmental Specification	
Impedance	50 & 75 ohm	Operation temperature	-55 to +155 Deg C
Frequency Range	50 ohm up to 18GHz 75 ohm up to 6GHz	IP Rating (Mated)	IP67
Dielectric Withstand Voltage	1500 Veff		
Insulation Resistance	5000 M-ohm		
Mechanical Specification		Materials	
Design Standard	IEC-61169-16	Centre Contact	Phosphor Bronze/Beryllium Copper/Brass
ROHS Compliant	Yes	Outer Contact	Brass
Mating Cycles	500	Insulator	PTFE
Contact Retention	13N min	Coupling Nut	Brass
Mating Force	26N max	Centre Contact Plating	Gold
Un-coupling Force	13.6N max	Outer Contact Plating	Nickel/White Bronze

## N Type 50 ohm interface.



Note - 50 and 75 ohm versions of N Type connectors are not compatible and permanent damage to the connector may occur if mated.

## N Type 75 ohm interface.

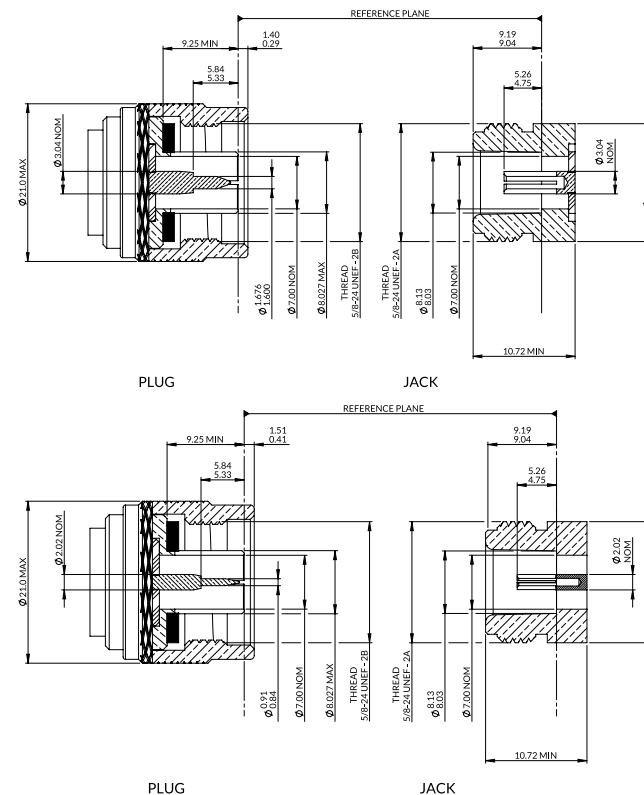





Figure 1

### Straight cable plug for flexible cable.

The range of straight N Type crimp cable plugs fit a wide selection of standard flexible and semi-rigid and conformable coaxial cables for both 50 and 75 ohm applications.

Connectors for flexible cable are crimped whereas those for semi-rigid and conformable cables are soldered. All connectors have gold plated centre contacts with nickel plated outer contact and body parts.

Crimp sizes are shown in the table and suitable tooling can be found in the Accessories & Tooling section of this catalogue.

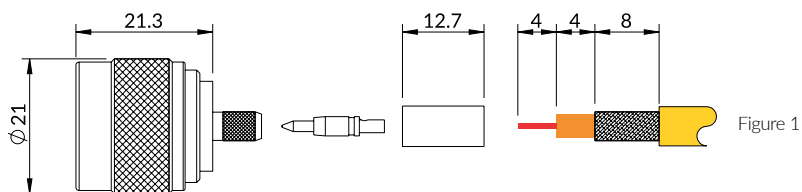

Figure 1



Figure 2

### Straight direct solder cable plug for Semi-Rigid cables.

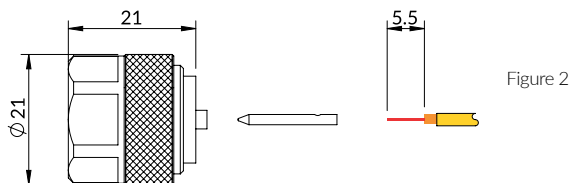

Figure 2

Part Number	Cable Types (for more see appendix)	$\Omega$	Cable Group	Assembly Procedure	Centre Contact	Outer Contact	Features
25-005-AO-AM	RG11,KX8	50	AM	AP001	2.54 Hex	10.9 Hex	Figure 1
25-005-B3-AH	RG58,RG141 Times LMR®195	50	AH	AP001	1.72 Hex	5.41 Hex	Figure 1
25-005-B3-AK	RG223	50	AK	AP001	1.72 Hex	6.5 Hex	Figure 1
25-005-B3-AN	RG213,URM67,KX4	50	AN	AP001	2.54 Hex	10.9 Hex	Figure 1
25-005-B3-AO	RG214	50	AO	AP001	2.54 Hex	10.9 Hex	Figure 1
25-005-B3-AU	RG400,RG142	50	AU	AP001	1.72 Hex	5.41 Hex	Figure 1
25-005-B3-DA	Times LMR®200	50	DA	AP001	1.72 Hex	5.41 Hex	Figure 1
25-005-B3-DB	Times LMR®240, Belden 155	50	DB	AP001	1.72 Hex	5.41 Hex	Figure 1
25-005-B3-DC	Times LMR®300	50	DC	AP001	1.72 Hex	5.41 Hex	Figure 1
25-025-B3-DC	Times LMR®300	50	DC	AP004	Solder	5.41 Hex	***
25-005-B3-DE	See appendix for details on pages 198-203	50	DE	AP004/ AP001	3.25 Hex	10.9 Hex	Figure 1 **
25-005-B6-AB	RG179,RG187,Belden179DT	75	AB	AP001	1.07 Sq	3.25 Hex	Figure 1 !
25-005-B6-AI	RG59,RG62,URM70	75	AI	AP001	1.72 Hex	6.5 Hex	Figure 1 !
25-006-B3-AD	See appendix for details on pages 198-203	50	AD	AP002	1.72 Hex	5.41 Hex	Figure 1 4 Part*
25-006-B3-AE	RD316,RD188	50	AE	AP002	1.72 Hex	5.41 Hex	Figure 1 4 Part*
25-014-B3-HA	RG401 (.085")	50	HA	AP033	Solder	Solder	Figure 2 ***
25-014-B3-HB	RG402 (.141")	50	HB	AP033	Solder	Solder	Figure 2 ***

**!** Note - Damage may occur if 50 and 75 ohm connectors are mixed.  
 \*Items marked '4 Part' are for small cables and include a supporting sleeve for reliable assembly.  
 \*\*Soldering of centre conductor is recommended for optimum performance (AP004)  
 \*\*\*Fitted with hexagon & knurl coupling nut in place of the standard knurled nut





## Straight solder / clamp cable plug.

Solder clamp plugs allow connectors to be assembled without the use of specialist tooling. The contact is simply soldered to the centre conductor of the prepared cable and a clamp system completes the assembly.

Connectors are available to suit a range of both 50 and 75 ohm cables.

Centre contacts are gold plated, the outer contacts and other body parts are nickel plated.

Part Number	Cable Types (for more see appendix)	$\Omega$	Cable Group	Assembly Procedure	Centre Contact	Outer Contact	Features
25-001-AO-AM	RG11,KX8	50	AM	AP016	Solder	Clamp	
25-001-B3-AH	RG58,RG141, Times LMR®195	50	AH	AP016	Solder	Clamp	
25-001-B3-AK	RG223	50	AK	AP016	Solder	Clamp	
25-001-B3-AN	RG213,URM67,KX4	50	AN	AP016	Solder	Clamp	
25-001-B3-DE	Times LMR®400, RG8,9913	50	DE	AP016	Solder	Clamp	
25-001-B6-AI	RG59,RG62,URM70	75	AI	AP016	Solder	Clamp	!

For full details of assembly procedures, go to [www.coax-connectors.com/ap](http://www.coax-connectors.com/ap)  
 ! Damage may occur if 50 and 75 ohm connectors are mixed.

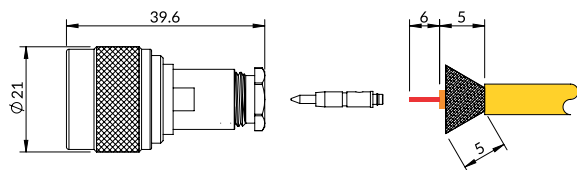

## Straight easy fit cable plug.

Easy Fit plugs are assembled without the need to solder the centre contact. Designed for use on the larger coaxial cables, the centre conductor of the stripped cable is pushed into the rear of the connector where the spring tines on the contact grip the conductor, giving a robust, solder free joint. The outer braid and jacket is terminated either by clamping or hexagon crimp, depending on the connector chosen.

The Easy Fit clamp styles are one of the simplest connectors to assemble, requiring only a cable stripper and spanners to complete the task.



Figure 1

Figure 2

Part Number	Cable Types (for more see appendix)	$\Omega$	Cable Group	Assembly Procedure	Centre Contact	Outer Contact	Features
25-017-B3-DE	See appendix for details on pages 198-203	50	DE	AP010	Easy Fit	Clamp	Figure 1
25-018-B3-DE	See appendix for details on pages 198-203	50	DE	AP25-018	Easy Fit	10.9 Hex	Figure 2
25-017-B3-DG	Times LMR®500	50	DG	AP010	Easy Fit	Clamp	Figure 1
25-017-B3-DH	Times LMR®600	50	DH	AP010	Easy Fit	Clamp	Figure 1

For full details of assembly procedures, go to [www.coax-connectors.com/ap](http://www.coax-connectors.com/ap)  
 ! Damage may occur if 50 and 75 ohm connectors are mixed.

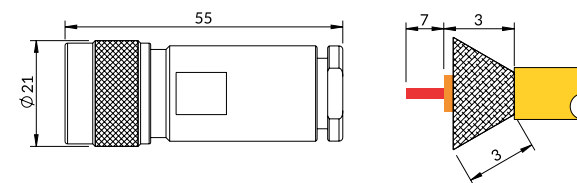

Figure 1

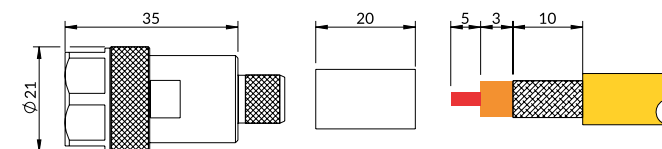

Figure 2

## Right angle cable plug.

Right angle plugs for assembly to a wide range of flexible cables. Centre conductors are soldered. Options are available for either clamp or crimp fixing of the outer conductor, these options vary according to cable type.

Centre conductors are gold plated and outer conductor and other body parts are nickel plated.

Crimp sizes are shown in the table and suitable tooling can be found in the Accessories & Tooling section of this catalogue.



Part Number	Cable Types (for more see appendix)	$\Omega$	Cable Group	Assembly Procedure	Centre Contact	Outer Contact	Features
25-105-A3-AH	RG58, RG141, Times LMR®195	50	AH	AP017	Solder	5.41 Hex	Figure 1
25-105-A3-AU	RG400, RG142	50	AU	AP017	Solder	5.41 Hex	Figure 1
25-105-B3-AD	See appendix for details on pages 198-203	50	AD	AP017	Solder	3.25 Hex	Figure 1
25-105-B3-AE	RD316, RD188	50	AE	AP017	Solder	3.84 Hex	Figure 1
25-105-B3-AK	RG223	50	AK	AP017	Solder	6.5 Hex	Figure 1
25-105-B3-AN	RG213, URM67, KX4	50	AN	AP017	Solder	10.9 Hex	Figure 1
25-101-B3-AN	RG213, URM67, KX4	50	AN	AP015	Solder	Clamp	Figure 2
25-105-B3-AO	RG214	50	AO	AP017	Solder	10.9 Hex	Figure 1
25-109-B3-AO	RG214	50	AO	AP017	Solder	10.9 Hex	Figure 1*
25-109-B3-DB	Times LMR®240, Belden 155	50	DB	AP017	Solder	5.41 Hex	Figure 1*
25-110-B3-DE	See appendix for details on pages 198-203	50	DE	AP017	Solder	10.9 Hex	Figure 1*
25-101-B3-DE	See appendix for details on pages 198-203	50	DE	AP015	Solder	Clamp	Figure 2

For full details of assembly procedures, go to [www.coax-connectors.com/ap](http://www.coax-connectors.com/ap)

\*Coupling nut has hexagon & knurl in place of standard knurl

**! Damage may occur if 50 and 75 ohm connectors are mixed.**

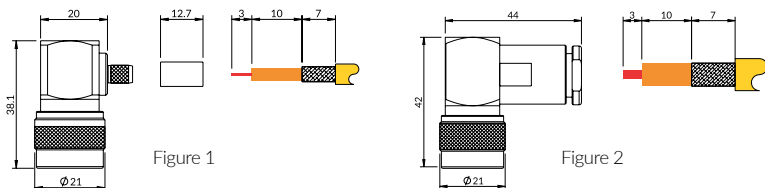

## Bulkhead and flange mount plugs.

Various options for bulkhead mounting plugs are offered including 4 hole flange and double D hole mounting.

Centre contacts are all gold plated, the 4 hole flange versions are bright nickel plated whereas the single hole bulkhead mount connector is non reflective black nickel plated.

The cable version is assembled by crimping the centre and outer conductors. Crimp sizes are shown in the table and suitable tooling can be found in the Accessories & Tooling section of this catalogue.

Figure 3



Figure 2



Figure 1

Part Number	Cable Types (for more see appendix)	$\Omega$	Cable Group	Assembly Procedure	Centre Contact	Outer Contact	Features
25-322-B3-AD	RG174, RG188, RG316, Times LMR®100	50	AD	AP019	1.73 Hex	5.41 Hex	Figure 3 4 Hole flange
25-233-A3		50		N/A	Solder bucket		Figure 2 4 Hole flange
25-364-J3		50		N/A	Solder bucket		Figure 1 Black nickel plated. Includes nut and washer

For full details of assembly procedures, go to [www.coax-connectors.com/ap](http://www.coax-connectors.com/ap)

**! Damage may occur if 50 and 75 ohm connectors are mixed.**

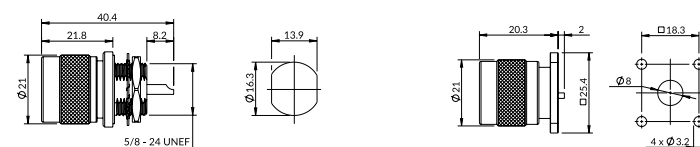

Figure 1

Figure 2

Figure 3



## Straight crimp cable jack.

Crimp jacks are available for a range of standard coaxial cables.

Centre conductors are gold plated, outer conductor and body parts are nickel plated.

Crimp sizes are shown in the table and suitable tooling can be found in the Accessories & Tooling section of this catalogue.

Part Number	Cable Types (for more see appendix)	$\Omega$	Cable Group	Assembly Procedure	Centre Contact	Outer Contact	Features
25-054-B3-AD	See appendix for details on pages 198-203	50	AD	AP001	1.72 Hex	5.41 Hex	
25-054-B3-AH	RG58, RG141, Times LMR®195	50	AH	AP001	1.72 Hex	5.41 Hex	
25-054-B3-AK	RG223	50	AK	AP001	2.54 Hex	6.5 Hex	
25-054-B3-AN	RG213, URM67, KX4	50	AN	AP001	2.54 Hex	10.9 Hex	
25-054-B3-AO	RG214	50	AO	AP001	2.54 Hex	10.9 Hex	
25-054-B3-DB	Times LMR®240, Belden 155	50	DB	AP001	1.72 Hex	5.41 Hex	
25-054-B3-DE	See appendix for details on pages 198-203	50	DE	AP004/ AP001	3.25 Hex	10.9 Hex	* See Notes
25-054-B6-AI	RG59, RG62, URM70	75	AI	AP001	1.72 Hex	6.5 Hex	!

For full details of assembly procedures, go to [www.coax-connectors.com/ap](http://www.coax-connectors.com/ap)  
\*Soldering of centre conductor is recommended for optimum performance (AP004)

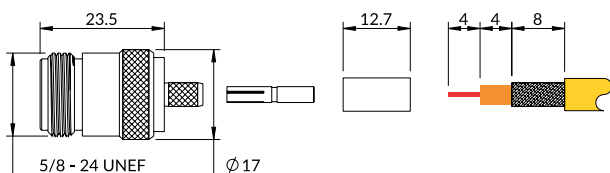

Note - 50 and 75 ohm versions of N Type connectors are not compatible and permanent damage to the connector may occur if mated.

## Straight clamp & easy fit cable jack.

For simpler assembly the clamp and Easy Fit range of cable jacks require less tooling to assemble.

Clamp jacks require only soldering of the centre conductor, the braid and jacket use a clamp mechanism to complete the assembly. Easy Fit connectors feature a centre contact where the conductor is pushed in and gripped by spring tines, giving a reliable and simple termination.

Centre conductors are gold plated, outer conductor and body parts are nickel plated.

Tooling can be found in the Accessories & Tooling section of this catalogue.



Figure 1

Figure 2

Part Number	Cable Types (for more see appendix)	$\Omega$	Cable Group	Assembly Procedure	Centre Contact	Outer Contact	Features
25-050-B3-AH	RG58, RG141, Times LMR®195	50	AH	AP010	Solder	Clamp	Figure 1
25-050-B3-AN	RG213, URM67, KX4	50	AN	AP010	Solder	Clamp	Figure 1
25-050-B6-AI	RG59, RG62, URM70	75	AI	AP016	Solder	Clamp	Figure 1 !
25-051-B3-AN	RG213, URM67, KX4	50	AN	AP016	Solder	Clamp	Figure 1
25-067-B3-DH	Times LMR®600	50	DH	AP25-010	Solderless	Clamp	Figure 1 Easy Fit
25-068-B3-DE	See appendix for details on pages 198-203	50	DE	AP025-016	Solderless	10.9 Hex	Figure 2 Easy Fit

For full details of assembly procedures, go to [www.coax-connectors.com/ap](http://www.coax-connectors.com/ap)  
! Damage may occur if 50 and 75 ohm connectors are mixed.

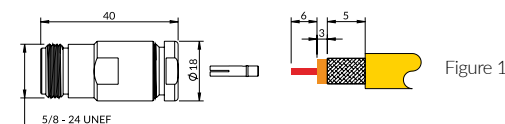

Figure 1

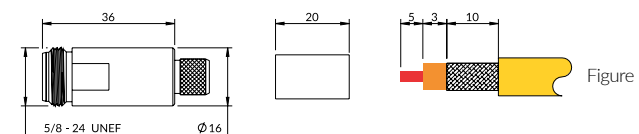

Figure 2



Figure 1

Figure 2

## Straight bulkhead rear mount cable jack.

Bulkhead mount jacks are available for a range of standard flexible and semi-rigid coaxial cables.

Centre conductors are gold plated, outer conductor and body parts are nickel plated.

Connectors for flexible cable have crimped centre contacts, outer contacts are also crimped. When fitted to semi-rigid or conformable cables, centre contacts are soldered and the outer conductor is soldered directly to the rear body of the connector.

A seal on the flange provides IP67 protection.

Crimp sizes are shown in the table and suitable tooling can be found in the Accessories & Tooling section of this catalogue.

Part Number	Cable Types (for more see appendix)	$\Omega$	Cable Group	Assembly Procedure	Centre Contact	Outer Contact	Features
25-254-B3-AN	RG213,URM67,KX4	50	AN	AP001	2.54 Hex	10.9 Hex	Figure 1
25-254-B3-DB	Times LMR®240, Belden 155	50	DB	AP001	1.72 Hex	5.41 Hex	Figure 1
25-255-B3-AD	See appendix for details on pages 198-203	50	AD	AP036	2.54 Hex	5.41 Hex	Figure 2 5 part
25-255-B3-AH	RG58,RG141, Times LMR®195	50	AH	AP001	1.72 Hex	5.41 Hex	Figure 2
25-255-B3-AK	RG223	50	AK	AP001	1.72 Hex	6.5 Hex	Figure 2
25-255-B3-DE	See appendix for details	50	DE	AP004/ AP001	2.54 Hex	10.9 Hex	Figure 2 * See Notes
25-255-H3-HA	RG45 (.085")	50	HB	AP033	Solder	Solder	Direct Solder, outline not shown below
25-255-H3-HB	RG402 (.141")	50	HB	AP033	Solder	Solder	Direct Solder, outline not shown below

For full details of assembly procedures, go to [www.coax-connectors.com/ap](http://www.coax-connectors.com/ap)  
 \* For optimum performance, the centre conductor should be soldered, use assembly procedure AP004.  
**! Damage may occur if 50 and 75 ohm connectors are mixed.**

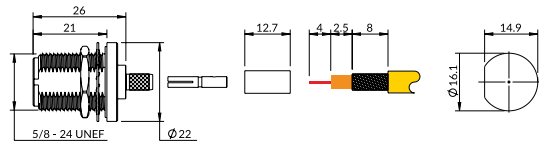

Figure 1

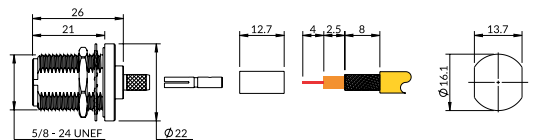

Figure 2

## Straight flange mount cable jack, crimp & direct solder.

Flange mount cable jacks for both flexible and semi-rigid cables, with a range of different 4 hole flange sizes.

Centre conductors are gold plated, outer conductor and body parts are nickel plated.

Crimp sizes are shown in the table and suitable tooling can be found in the Accessories & Tooling section of this catalogue.



Part Number	Cable Types (for more see appendix)	$\Omega$	Cable Group	Assembly Procedure	Centre Contact	Outer Contact	Features
25-278-B3-AE	RD316,RD188	50	AE	AP001	1.72 Hex	5.41 Hex	Figure 1
25-278-B3-AH	RG58,RG141, Times LMR®195	50	AH	AP001	1.72 Hex	5.41 Hex	Figure 1
25-278-B3-AK	RG223	50	AK	AP001	1.72 Hex	6.5 Hex	Figure 1
25-278-B3-AN	RG213,URM67,KX4	50	AN	AP001	2.54 Hex	10.9 Hex	Figure 1
25-279-B3-HA	RG405(.085")	50	HA	AP033	Solder	Solder	Figure 3 Sealed
25-279-B3-HB	RG402 (.141")	50	HB	AP033	Solder	Solder	Figure 3 Sealed
25-279-B3-HA-17.5mm	RG405(.085")	50	HA	AP033	Solder	Solder	Figure 2 Sealed
25-283-Q3-HA-17.5mm	RG405(.085")	50	HA	AP033	Solder	Solder	Figure 2 White Bronze plated body

For full details of assembly procedures, go to [www.coax-connectors.com/ap](http://www.coax-connectors.com/ap)  
**! Damage may occur if 50 and 75 ohm connectors are mixed.**

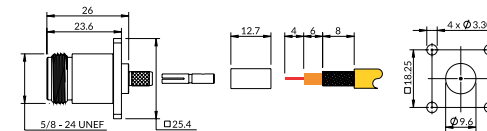

Figure 1

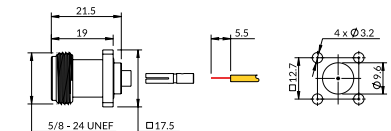

Figure 2

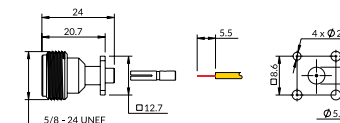

Figure 3

## Front mount bulkhead jack.

Front mounted jacks with solder bucket termination. This connector is supplied complete with fixing nut and either with or without solder tag.

Centre conductors are gold plated, outer conductor and body parts are nickel plated.



Part Number	Ω	Centre Contact	Features
25-350-B3	50	Solder bucket	Connector and nut only - Figure 1
25-360-B3	50	Solder bucket	Connector with solder tag and nut - Figure 2

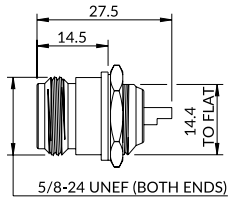

Figure 1

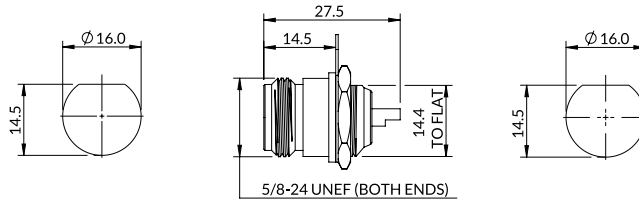

Figure 2

## Bulkhead 4 hole flange mount jack.

Flange mount cable jacks with solder bucket termination. Centre conductors are gold plated, outer conductor and body are nickel plated.



Part Number	Ω	Centre Contact	Features
25-371-B3	50	Solder bucket	1" (25.4mm) square flange

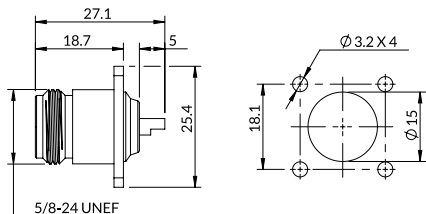

## Dust cap & shorting cap.

Dust caps provide IP67 protection for an unmated connector port. Shorting caps can also be supplied.

Caps are fitted with gold plated centre contacts, the outer body parts are nickel plated.

Part Number	Ω	Descriptions
25-850-Z		Plug Dust Cap (Not illustrated)
25-852-Z		Jack Dust Cap (Not illustrated)
25-859-Z	50	Plug Shorting Cap
25-858-Z	50	Jack Shorting Cap



Plug shorting cap.



Jack shorting cap.

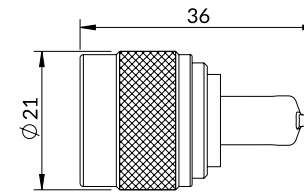

Plug shorting cap.

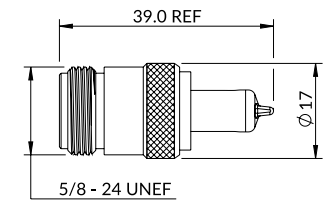

Jack shorting cap.



Note - 50 and 75 ohm versions of N Type connectors are not compatible and permanent damage to the connector may occur if mated.

# Adaptors.

Adaptors in a range of configurations for connection within the series of N Type connectors. For connecting N Types to other coaxial connector types, see our range of Inter Series Adaptors.

All adaptors have gold plated centre contacts and bodies are nickel plated.

**Important note - All adaptors shown are 50 ohm and must not be mated with 75 ohm connectors or damage will occur.**

Figure 1



Figure 2

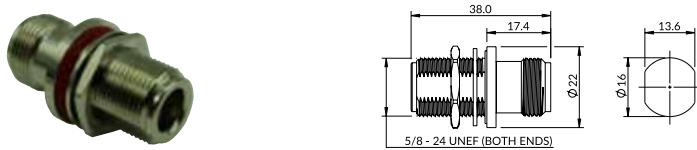

Figure 3

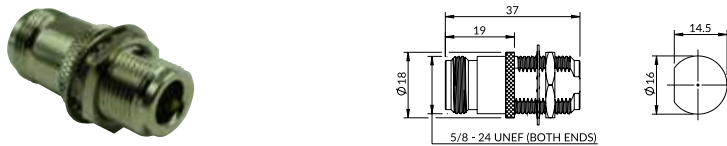

Figure 4



Figure 5



Figure 6



Part Number	Ω	Left	Interface Arrangement Centre	Right	Features
25-500-B3	50	Jack		Jack	Figure 1
25-501-1-B3	50	Jack		Jack	Figure 2 With bulkhead sealing gasket
25-501-B3	50	Jack		Jack	Figure 3
25-514-B3	50	Plug		Plug	Figure 4
25-520-1-B3	50	Jack		Plug	Figure 5
25-520-B3	50	Jack		Plug	Figure 5 Non-hex coupling nut
25-523-A3	50	Jack	Plug	Jack	Figure 6

**!** Note - 50 and 75 ohm versions of N Type connectors are not compatible and permanent damage to the connector may occur if mated.



## DIN 41626 inserts.

DIN 41626 inserts. Coaxial connectors used in conjunction with DIN 41612 mixed layout housings. A metal 'C' clip on the connector body locks into the plastic housing of the DIN 41612 which also allows sufficient float for correct mating.

These inserts have gold plated centre and outer contact and are suitable for use up to 2GHz



## Specification.

Electrical Specification		Environmental Specification	
Impedance	50 ohm	Operation temperature	-55 to +155 Deg C
Frequency Range	Up to 2GHz	IP Rating (Mated)	IP40
Dielectric Withstand Voltage	250 Veff		
Insulation Resistance	200M-ohm		
Mechanical Specification		Materials	
Design Standard	IEC 41626	Centre Contact	Beryllium Copper
ROHS Compliant	Yes	Outer Contact	Brass/Phosphor Bronze
Mating Cycles	500	Insulator	PTFE
Contact Retention	10N min		
Mating Force	10N max	Centre Contact Plating	Gold
Un-coupling Force	10N max	Outer Contact Plating	Gold

The above values are typical. Please check product data sheets for full details - see [www.coax-connectors.com](http://www.coax-connectors.com) or call +44(0)20 8538 9090

## DIN 41626 interface.

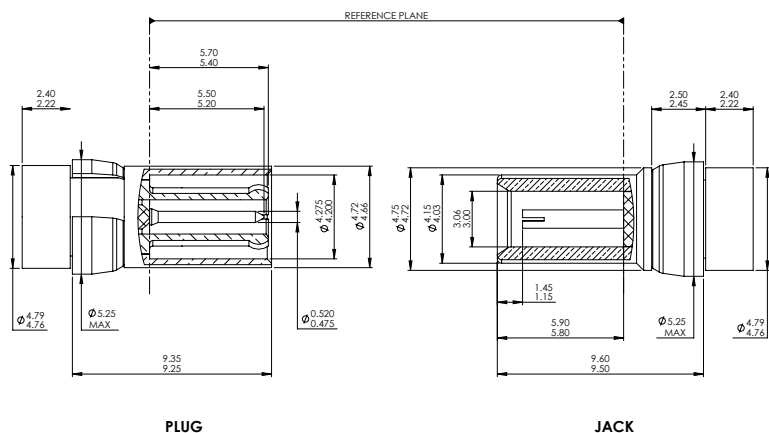

## Cable plug.

A cable mounted cable plug, the gold plated centre and outer conductors are crimped using standard crimp methods.

Crimp sizes are shown in the table and suitable tooling can be found in the accessories section of this catalogue. The 'C' clip locks the connector to the DIN 41612 housing and provides float for ease of mating.



Part Number	Cable Types (for more see appendix)	Cable Group	Assembly Procedure	Centre Contact	Outer Contact	Features
29-005-D3-AD	See appendix for details on pages 198-203	AD	AP001	1.07 Sq	3.25 Hex	

For full details of assembly procedures, go to [www.coax-connectors.com/ap](http://www.coax-connectors.com/ap)

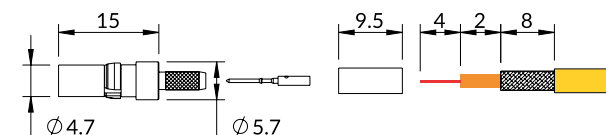

## PCB jack.

A right angle PCB jack with gold plated centre and outer conductors and 'C' for mounting to the DIN 41612 housing.

Part Number	Centre Contact	Outer Contact	Features
29-468-D6	Solder	Solder	PCB mount

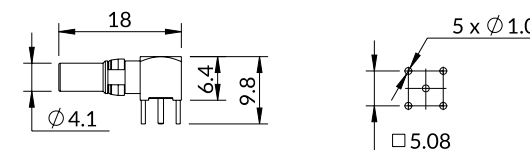



# SMA connectors.

SMA sub-miniature series are a popular general purpose high performance 50 ohm connector. SMA have a screw together coupling with versions available for use up to 12.5 GHz and feature gold plated bodies and centre contacts. SMA connectors are suited to a wide variety of industries from high performance applications in defence and aerospace to general purpose industrial. Reverse polarity versions are also available.

## Key features:

- Excellent RF performance
- Most popular sub-miniature connector world-wide
- Reliable and secure nut coupling
- For use with flexible and semi-rigid cables
- IP68 bulkhead jacks available
- Wide range of body styles

SMA	Page
Straight solder clamp plug and Easy Fit crimp	116
Straight crimp plug	117
Straight & right angle direct solder plug for Semi-Rigid cable	118
Right angle crimp plug	119
Flange mount plug	119
End launch PCB plug	120
Straight crimp jack	122
Straight bulkhead rear mount cable jack	123-124
Straight Easy Fit cable jack	124
Rear mount bulkhead solder jack	125
Straight bulkhead jack front mount	125
Straight PCB jack	126
Right angle PCB jack	127
End launch PCB jack	128-129
Straight flange mount jack	130
Shorting cap & dust cap to fit SMA jack	131
Attenuator	131
Adaptors	132-133
SMA Reverse Polarity	134-135



## New connectors.

We are regularly designing new connectors to enhance our range, if you can not find what you need, please contact us.

## Specification.

Electrical Specification		Environmental Specification	
Impedance	50 ohm	Operation temperature	-55 to +155 Deg C
Frequency Range	Up to 12.5GHz	IP Rating (Mated)	IP67/IP68
Dielectric Withstand Voltage	750 Veff		
Insulation Resistance	5000 M-ohm		
Mechanical Specification		Materials	
Design Standard	IEC-61169-15	Centre Contact	Brass/Beryllium Copper
ROHS Compliant	Yes	Outer Contact	Brass
Mating Cycles	500*	Insulator	PTFE
Contact Retention	22N min	Coupling Nut	Brass
Coupling Nut Torque	0.25Nm max	Centre Contact Plating	Gold
		Outer Contact Plating	Gold

\*When mated with a connector made of the same material.  
The above values are typical. Please check product data sheets for full details - see [www.coax-connectors.com](http://www.coax-connectors.com) or call +44(0)20 8538 9090

## SMA interface.

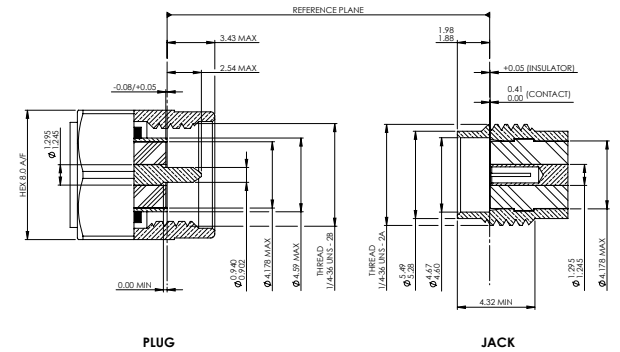

## SMA reverse polarity interface.

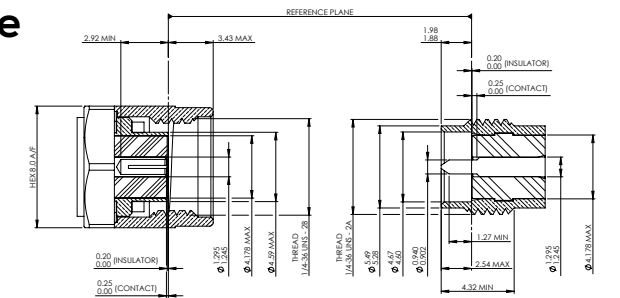

## Straight plug, Easy Fit/crimp and solder/clamp.

Figure 1



Figure 2



Straight clamp plugs can be assembled without the use of specialist crimp tooling. The centre conductor is soldered to the contact and the cable and braid are held in place by a simple clamp mechanism.

Inner contact and other body parts are gold plated.

Part Number	Typical Cable Types (for more see appendix)	Cable Group	Assembly Procedure	Centre Contact	Outer Contact	Features
30-001-D3-AH	RG58, RG141, Times LMR®195	AH	AP018	Solder	Clamp	Figure 1
30-018-B3-DE	RG223	AK	AP25-018	Easy Fit	Crimp	Figure 2

For full details of assembly procedures, go to [www.coax-connectors.com/ap](http://www.coax-connectors.com/ap)

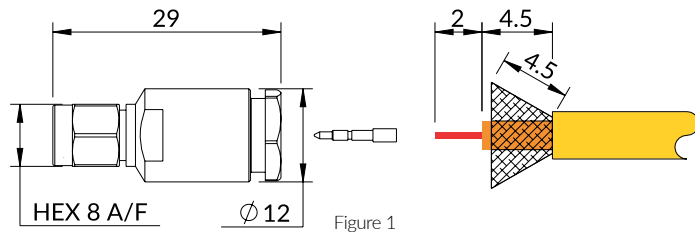

Figure 1

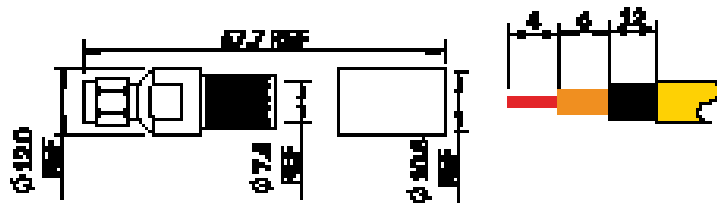

Figure 2

## Straight crimp plug.

These SMA plugs have gold plated crimped or soldered centre contacts and crimped outer conductor giving a high reliability connection. For best performance centre contacts should be crimped.

Inner contact and other body parts are gold plated.

See table for crimp sizes; suitable tooling can be found in the Accessories & Tooling section of this catalogue.



Part Number	Typical Cable Types (For more see appendix)	Cable Group	Assembly Procedure	Centre Contact	Outer Contact	Features
30-005-B3-AD	RG174, RG188, RG316, Times LMR®100	AD	AP001	1.07 Sq	3.25 Hex	Figure 1
30-005-B3-AH	RG58, RG141, Times LMR®195	AH	AP001	1.72 Hex	5.41 Hex	Figure 1
30-005-B3-DB	Times LMR®240	DB	AP001	1.72 Hex	5.41 Hex	Figure 1
30-005-D3-AA	RG178, RG196	AA	AP001	1.07 Sq	3.25 Hex	Figure 1
30-005-D3-AD	RG174, RG188, RG316, Times LMR®100	AD	AP001	1.07 Sq	3.25 Hex	Figure 1
30-005-D3-AE	RD316, RD188	AE	AP001	1.07 Sq	3.84 Hex	Figure 1
30-005-D3-AH	RG58, RG141, Times LMR®195	AH	AP001	1.72 Hex	5.41 Hex	Figure 1
30-005-D3-AK	RG223	AK	AP001	1.72 Hex	6.5 Hex	Figure 1
30-005-D3-DA	Times LMR®200	DA	AP001	1.72 Hex	5.41 Hex	Figure 1
30-005-D3-DB	Times LMR®240	DB	AP001	1.72 Hex	5.41 Hex	Figure 1
30-008-D3-AH	RG58, RG141, Times LMR®195	AH	AP004	Solder	5.41 Hex	Figure 2
30-008-D3-DE	See appendix for details on pages 198-203	DE	AP004	Solder	10.9 Hex	Figure 2

For full details of assembly procedures, go to [www.coax-connectors.com/ap](http://www.coax-connectors.com/ap)

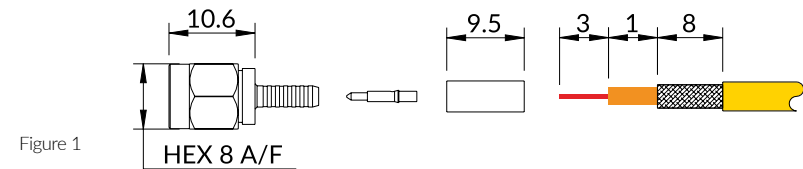

Figure 1

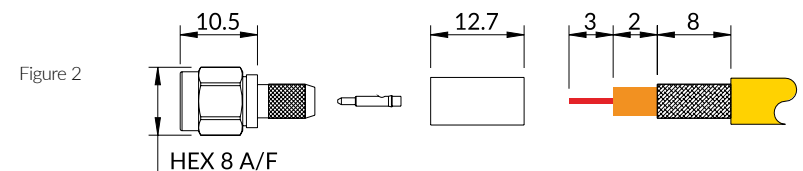

Figure 2

## Straight & right angle direct solder plug for semi-rigid cable.

For use with semi-rigid or conformable cables, these straight and right angle plugs are soldered directly to the cables. The centre conductor is soldered to the contact and the outer jacket of the cable is soldered directly to the rear body of the connector. The right angle version has a small cap which is then used to cover over the contact joint.

Inner contact and other body parts are gold plated.



Part Number	Cable Types (for more see appendix)	Cable Group	Assembly Procedure	Centre Contact	Outer Contact	Features
30-014-D3-HA	RG405(.085")	HA	AP033	Solder	Solder	Straight, Figure 1
30-014-D3-HB	RG402 (.141")	HB	AP033	Solder	Solder	Straight, Figure 1
30-108-D3-HA	RG405(.085")	HA	AP044	Solder	Solder	Right Angle, Figure 2
30-108-D3-HB	RG402 (.141")	HB	AP044	Solder	Solder	Right Angle, Figure 2

For full details of assembly procedures, go to [www.coax-connectors.com/ap](http://www.coax-connectors.com/ap)

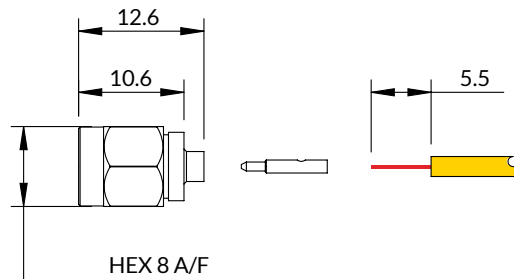

Figure 1

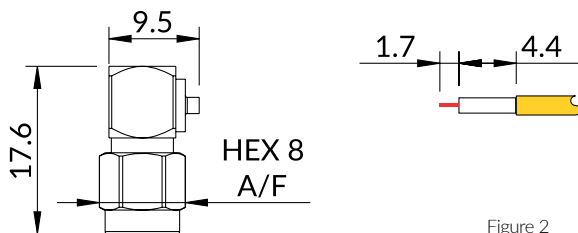

Figure 2

## Right angle crimp plug.

These right angle connectors have a fixed centre contact which is soldered through an aperture in the body. Once soldered the aperture is sealed with a cap and the outer braid conductor is crimped to complete the assembly.

Inner contact and other body parts are gold plated.

See table for crimp sizes; suitable tooling can be found in the Accessories & Tooling section of this catalogue.



Part Number	Cable Types (for more see appendix)	Cable Group	Assembly Procedure	Centre Contact	Outer Contact	Features
30-105-D3-AA	RG178, RG196	AA	AP017	Solder	3.25 Hex	4 part*
30-105-D3-AD	RG174, RG188, RG316, Times LMR@100	AD	AP017	Solder	3.25 Hex	
30-105-D3-AE	RD316, RD188	AE	AP017	Solder	3.84 Hex	
30-105-D3-AH	RG58, RG141, Times LMR@195	AH	AP017	Solder	5.41 Hex	
30-105-D3-AK	RG223	AK	AP017	Solder	6.5 Hex	

For full details of assembly procedures, go to [www.coax-connectors.com/ap](http://www.coax-connectors.com/ap)  
\*Items marked '4 Part' are for small cables and include a supporting sleeve for reliable assembly.

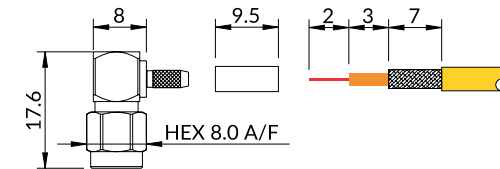

## Flange mount plug.

These 2 hole flange mount plugs have a solder stub contact and are available with either flush or extended dielectric.

Inner contact and other body parts are gold plated.

Part Number	Centre Contact	Features
30-319-D3	Solder - Stub contact	Figure 1
30-321-D3	Solder - Stub contact	Figure 2 - Extended dielectric
30-323-D3	Solder - Stub contact	4 hole 12.7mm square flange Not Shown

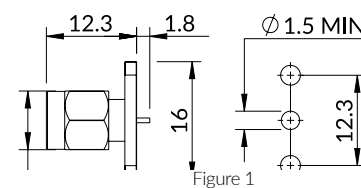

Figure 1

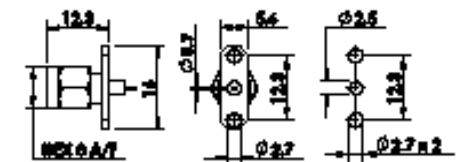

Figure 2

## End launch PCB plug.

This SMA plug is for fitting to the edge of a PCB. The gold plated inner contact and outer body are soldered to pads on the board.

Versions to suit either 1.22mm or 1.6mm boards are available.



Part Number	Dimension A (mm)	Dimension B (mm)	Centre Contact	Outer Contact	Features
30-427-D3-1.22	6.4	6.4	Solder	Solder	To suit 1.22mm thick PCB
30-428-D3-1.6	9.5	7.9	Solder	Solder	To suit 1.6mm thick PCB

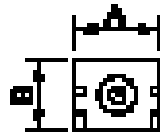
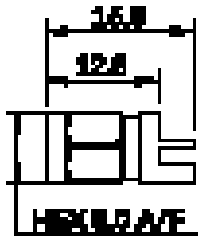

## SMA - IP68 sealed bulkhead connectors.

To support the increasing demand for high performance connectors used in more challenging environments, a range of SMA connectors incorporating IP68 sealing has been developed. These connectors are sealed when mated or unmated giving protection in water to a depth of 10 metres for at least 4 hours.

### Key features:

- IP68 Unmated
- Watertight at 10 metre depth for 4 hours
- Excellent RF performance
- Reliable and secure nut coupling
- IP68 Bulkhead sealed

Full details on the following pages

[www.coax-connectors.com](http://www.coax-connectors.com)



## Straight crimp jack.

Straight cable jacks for cable mounting. These jacks fit a range of popular cables and have crimped centre and outer contacts.

Inner contact and other body parts are gold plated.

See table for crimp sizes; suitable tooling can be found in the Accessories & Tooling section of this catalogue.

Part Number	Typical Cable Types (For more see appendix)	Cable Group	Assembly Procedure	Centre Contact	Outer Contact	Features
30-054-B3-AD	RG174, RG188, RG316, Times LMR®100	AD	AP001	1.07 Sq	3.25 Hex	Figure 1 Nickel Body
30-054-D3-AD	RG174, RG188, RG316, Times LMR®100	AD	AP001	1.07 Sq	3.25 Hex	Figure 1
30-069-D3-AD	RG174, RG188, RG316, Times LMR®100	AD	AP001	1.07 Sq	3.25 Hex	Figure 2
30-054-D3-AA	RG178, RG196	AA	AP001	1.07 Sq	3.25 Hex	Figure 1
30-054-D3-AE	RD316, RD188	AE	AP001	1.07 Sq	3.84 Hex	Figure 1
30-054-D3-AH	RG58, RG141, Times LMR®195	AH	AP001	1.72 Hex	5.41 Hex	Figure 1
30-054-D3-AK	RG223	AK	AP001	1.72 Hex	6.5 Hex	Figure 1
30-063-D3-HA	RG402(.141")	HB	AP033	Solder	Solder	Details not shown

For full details of assembly procedures, go to [www.coax-connectors.com/ap](http://www.coax-connectors.com/ap)

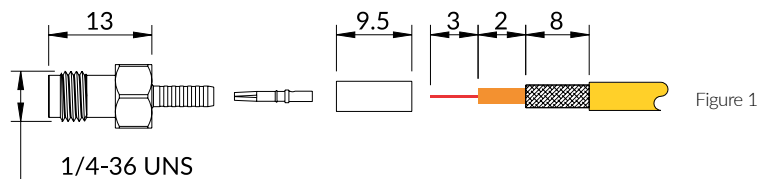

Figure 1

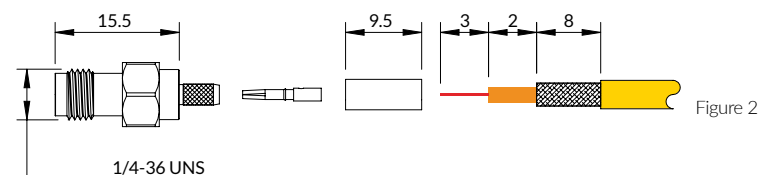

Figure 2

## Straight bulkhead rear mount cable jack.

These bulkhead mounted cable jacks have a panel seal to prevent moisture passing through the panel when connectors are mated. We also include an IP68 version which will offer the same protection when un-mated.

Connectors shown here are for both flexible and semi-rigid cables. Those to suit flexible cables utilise crimped centre and outer contacts. The versions for semi-rigid type cables have a soldered centre contact and the outer jacket is soldered directly to the spigot at the rear of the body.

Inner contact and other body parts are gold plated. Connectors are supplied complete with nut and lock washer for bulkhead assembly.

See table for crimp sizes; suitable tooling can be found in the Accessories & Tooling section of this catalogue.



Figure 1

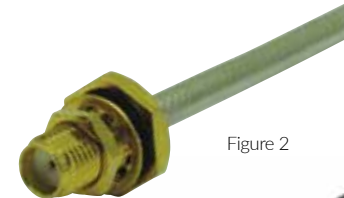

Figure 2



Figure 3

Outline drawings for these bulkhead jacks are shown on the following page

Part Number	Typical Cable Types (For more see appendix)	Cable Group	Assembly Procedure	Centre Contact	Outer Contact	Features
30-254-D3-AD	RG174, RG188, RG316, Times LMR®100	AD	AP001	1.07 Sq	3.25 Hex	Figure 1
30-290-D10-AD	RG174, RG188, RG316, Times LMR®100	AD	AP050	1.07 Sq	3.25 Hex	Figure 3 IP68 Un-mated
30-254-D3-AE	RD316, RD188	AE	AP001	1.07 Sq	3.84 Hex	Figure 1
30-254-D3-AH	RG58, RG141, Times LMR®195	AH	AP001	1.72 Hex	5.41 Hex	Figure 1
30-254-D3-AK	RG223	AK	AP001	1.72 Hex	6.5 Hex	Figure 1
30-256-B3-AA	RG178, RG196	AA	AP002	1.07 Sq	3.25 Hex	Figure 1, 4 Part* Nickel plated body
30-256-D3-AA	RG178, RG196	AA	AP002	1.07 Sq	3.25 Hex	Figure 1, 4 Part*
30-282-D3-AA	RG178, RG196	AA	AP002	1.07 Sq	3.25 Hex	Details not shown
30-266-D3-HA	RG405(.085")	HA	AP033	Solder	Solder	Figure 2 Direct Solder
30-266-D3-HB	RG402(0.141")	HB	AP033	Solder	Solder	Figure 2 Direct Solder

For full details of assembly procedures, go to [www.coax-connectors.com/ap](http://www.coax-connectors.com/ap)  
\*Items marked '4 Part' are for small cables and include a supporting sleeve for reliable assembly.



Outlines for bulkhead jacks shown on previous page

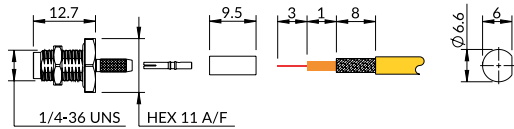

Figure 1

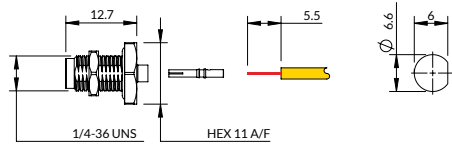

Figure 2

IP68

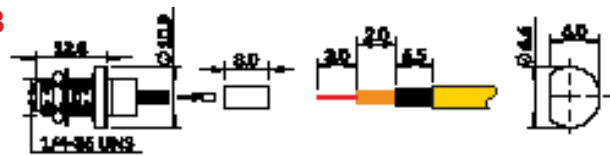

Figure 3

## Straight Easy Fit cable jack.

Easy Fit connectors offer a simple and speedy termination method where the centre contact is pre-assembled into the connector. The prepared cable is simply pushed into the rear of the connector and the centre conductor is captivated by the contact. To complete the assembly the outer conductor is crimped using industry standard tooling.

For more information on tooling, see the Accessories & Tooling section of this catalogue.

The centre contact is gold plated and outer body parts nickel plated.

Part Number	Typical Cable Types (For more see appendix)	Cable Group	Assembly Procedure	Centre Contact	Outer Contact	Features
30-068-B3-DE	See appendix for details on pages 198-203	DE	AP25-018	Easy Fit	10.9 Hex	

For full details of assembly procedures, go to [www.coax-connectors.com/ap](http://www.coax-connectors.com/ap)

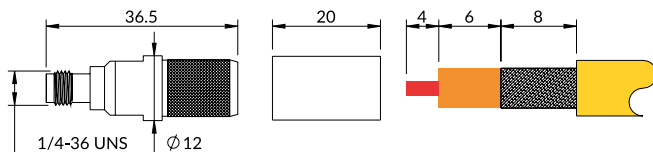

## Rear mount bulkhead solder jack.

This rear mount bulkhead jack has a solder bucket centre contact and is supplied complete with fixing nut and lock washer.

Centre contact and body are gold plated.



Part Number	Centre Contact	Outer Contact	Features
30-352-D3	Solder bucket	Bulkhead mount	Nut and washer included

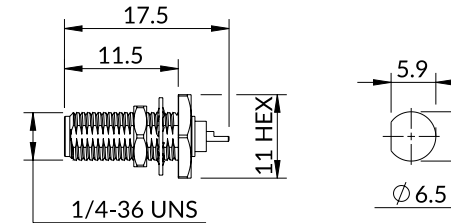

## Straight bulkhead jack front mount.

Front mount bulkhead jacks with either solder bucket or round stub contact and include an IP68 sealed version.

Centre contact and body are gold plated, fixing hardware is not included.

IP68



Part Number	Centre Contact	Outer Contact	Features
30-348-D3	Solder	Panel mounted	Figure 1 - Round contact
30-360-D3	Solder	Panel mounted	Figure 1 - Solder bucket
30-349-D3	Solder	Panel mounted	Figure 2 IP68 protected - Round contact

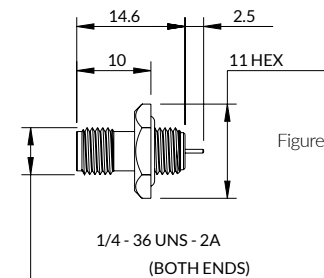

Figure 1

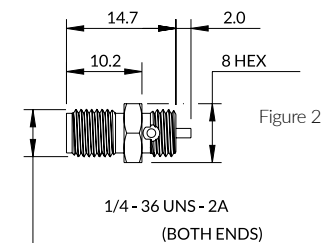

Figure 2

## Straight PCB jack.

Through hole solder straight SMA jacks are available for standard PCB mounting or for additional bulkhead fitting. The bulkhead mounted version is supplied with fixing nut and lock washer as standard.

Centre contact and body are gold plated.



Figure 1



Figure 2



Figure 3



Figure 4

Part Number	Centre Contact	Outer Contact	Dimension A (mm)	Dimension B (mm)	Dimension C (mm)	Features
30-450-D3	Solder	Solder				Figure 1
30-454-D3	Solder	Solder	15.5	12.7	1.5	Figure 2 - Supplied complete with nut and lock washer
30-454-D3-5.7	Solder	Solder	19.7	16.9	5.7	Figure 3 - Supplied complete with nut and lock washer
30-455-D3	Solder	Solder				Figure 4 - IP67 bulkhead seal Supplied complete with nut and washer

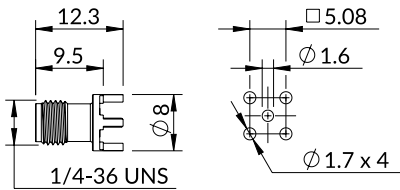

Figure 1

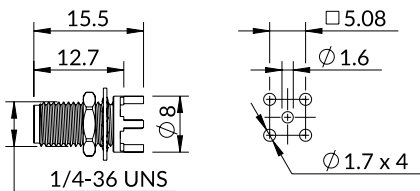

Figure 2 & 3

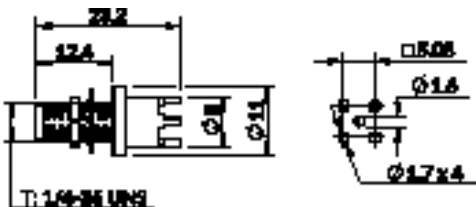

Figure 4

## Right angle PCB jack.

Right angle SMA jacks are available for either through hole soldering or with co-planar legs for surface mounting.

An IP68 extended thread, bulkhead mount, through hole soldered version is available, this version is supplied complete with fixing nut and lock washer.

Centre contact and body are gold plated.



Figure 1



Figure 2



Figure 3

Part Number	Centre Contact	Outer Contact	Features
30-465-D3	Solder	Solder	Figure 1 Through hole solder
30-467-D3	Solder	Solder	Figure 2 For surface mounting (coplanar centre and outer contacts)
30-468-1-D3	Solder	Solder	Figure 3 Through hole solder. IP68 sealed

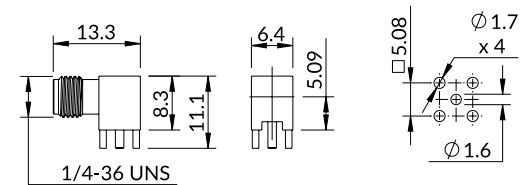

Figure 1

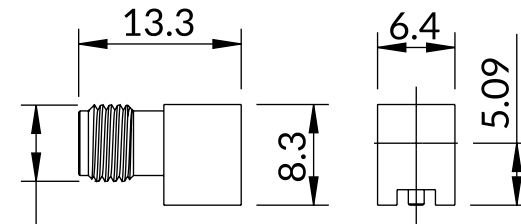

Figure 2

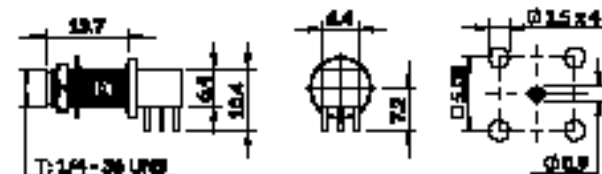

Figure 3



Figure 1

## End launch PCB jack.

For edge mount fitting to standard 1.6mm or 1.8mm thick PCBs, these connectors provide low profile mounting to solder pads on the board edge.

Options include a version with the centre line of the contact aligned to the plane of the PCB and a bulkhead mount version.

Centre contact and body are gold plated and the bulkhead fixing version includes a fixing nut and lock washer.



Figure 2



Figure 3

Part Number	Centre Contact	Outer Contact	PCB nominal thickness	Features
30-390-D3-1.6	Solder	Solder	1.6mm	Figure 1 Contact in alignment with PCB
30-459-D3 - 1.6mm	Solder	Solder	1.6mm	Figure 2
30-462-D3-1.6mm	Solder	Solder	1.6mm	Figure 3, Bulkhead mount, supplied complete with nut and washer
30-462-D3-1.8mm	Solder	Solder	1.8mm	Figure 3, Bulkhead mount, supplied complete with nut and washer

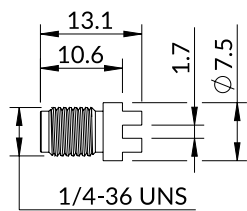

Figure 1

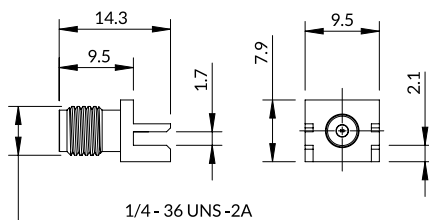

Figure 2

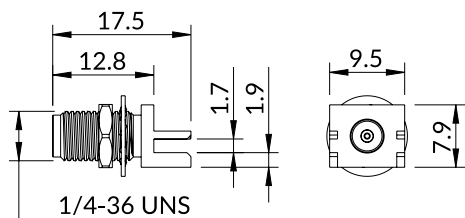

Figure 3

## End launch bulkhead jack.

For edge mount fitting to standard 1.6mm thick PCBs, and for bulkhead fitting with an IP68 seal that provides protection when unmated. These connectors provide low profile mounting to solder pads on the board edge.

Centre contact and body are gold plated and the bulkhead fixing version includes a fixing nut and lock washer.



Part Number	Centre Contact	Outer Contact	PCB nominal thickness	Features
30-462-1-D3-1.6	Solder	Solder	1.6mm	Figure 1 - IP68 sealed with 13mm flange
30-462-2-D3-1.6	Solder	Solder	1.6mm	Figure 2 - IP68 sealed with 10mm flange

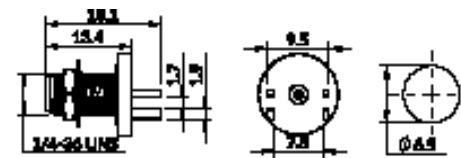

Figure 1

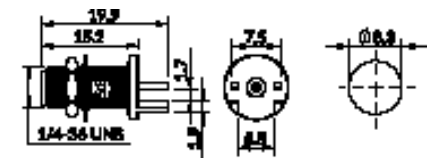

Figure 2

## End launch bulkhead jack for through hole mounting.

Designed to be mounted on the board edge, this connector has through hole solder pegs for additional mounting strength. The centre contact is in line with the top edge of the board and is designed for surface mount soldering.

Centre contact and body are gold plated and can be supplied with a fixing nut and lock washer.



Part Number	Centre Contact	Outer Contact	Features
30-410-D3	Solder	Solder	
30-410-1-D3	Solder	Solder	Includes fixing nut and lock washer

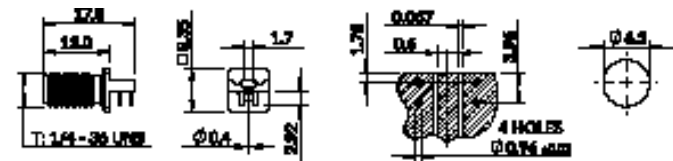

## Straight flange mount jack.

Flange mount SMA jack for either 2 or 4 hole fixing. The 4 hole variant has a flat tab solder contact whereas the 2 hole versions have a solder bucket.

Standard plating is gold for the contact and body, however the 2 hole flange version is also available with a nickel plated body.

Figure 1 & 3



Figure 2



Part Number	Centre Contact	Outer Contact	Features
30-372-D3	Solder	Panel mounted	4 hole flange with solder tab - Gold plated body Figure 1
30-368-D3	Solder	Panel mounted	2 hole flange with solder bucket - Gold plated body - Figure 2
30-368-B3	Solder	Panel mounted	2 hole flange with solder bucket - Nickel plated body - Figure 2
30-375-D3	Solder	Panel mounted	4 hole flange with solder bucket - Gold plated Figure 3

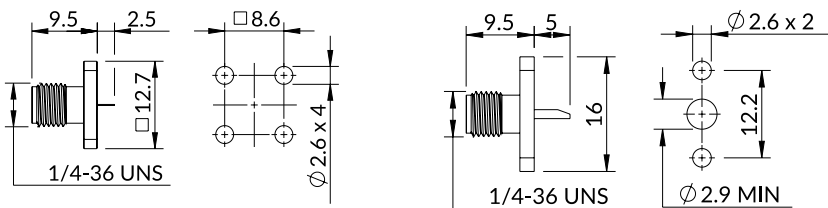

Figure 1

Figure 2

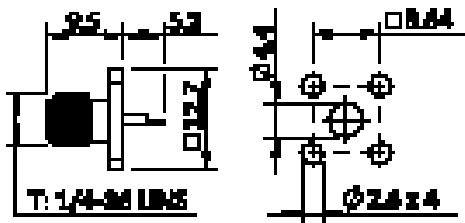

Figure 3

## Shorting cap & dust cap to fit SMA jack.

These sealed caps provides IP67 protection when mated with an SMA jack and include a chain and eyelet for securing to a nearby fixing point.

Part Number	Description	Chain Length	Eyelet Hole Ø
30-890-A3	Dust Cap	50mm	4mm
30-890-1-A3	Shorting Cap / Dust Cap	50mm	4mm



## SMA Plug to Jack 10dB 50W Attenuator, DC to 2.5GHz

SMA in line Plug to Jack Attenuator 10dB, 50W, DC to 2.5GHz the SMA connectors are hermetically sealed and have gold plated body and centre contact. The heatsink is machined aluminium with black anodised finish.



Part Number	Description
30-870-1	10dB, 50W Attenuator

## Adaptors.

Adaptors in a range of configurations for connection within the SMA series.  
For connecting SMA to other coaxial connector types, see our range of Inter Series Adaptors.

All adaptors have gold plated centre contacts and bodies.

Figure 1

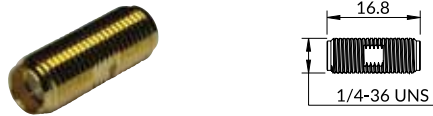

Figure 2

IP68

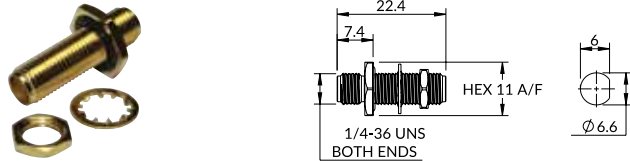

Figure 3

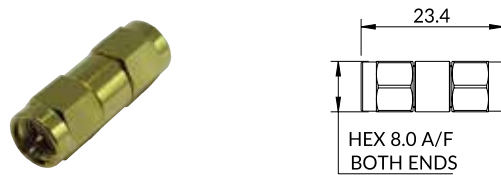

Figure 4



Figure 5



Figure 6

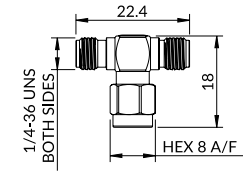

Part Number		Interface Arrangement			Figure	Features
		Left	Centre	Right		
30-500-D3	SMA Straight Adaptor	Jack		Jack	Fig. 1	
30-501-D10	SMA Bulkhead Adaptor	Jack		Jack	Fig. 2	IP68 sealed, mated and unmated
30-501-D3	SMA Bulkhead Adaptor	Jack		Jack	Fig. 2	
30-514-D3	SMA Straight Adaptor	Plug		Plug	Fig. 3	
30-520-D3	SMA Right Angle Adaptor	Plug		Jack	Fig. 4	
30-522-D3	SMA 'T' Adaptor	Jack	Jack	Jack	Fig. 5	
30-523-D3	SMA 'T' Adaptor	Jack	Plug	Jack	Fig. 6	

## RP straight crimp plug.

Reverse polarity version of standard crimp cable plug. This connector is available for a range of standard coaxial cables.

Reverse polarity connectors are ideal for use where it is necessary to differentiate between different lines and avoid incorrect connections.

Centre contact and body are gold plated except where otherwise stated.

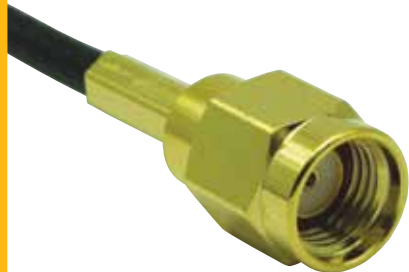

Part Number	Cable Types (for more see appendix)	Cable Group	Assembly Procedure	Centre Contact	Outer Contact	Features
31-005-A3-AD	See appendix for details on pages 198-203	AD	AP001	1.07 Sq	3.25 Hex	Nickel plated body
31-005-B3-AH	RG58, RG141, Times LMR®195	AH	AP001	1.72 Hex	5.41 Hex	Nickel plated body
31-005-D3-AD	See appendix for details on pages 198-203	AD	AP001	1.07 Sq	3.25 Hex	
31-005-D3-AH	RG58, RG141, Times LMR®195	AH	AP001	1.72 Hex	5.41 Hex	
31-005-D3-AK	RG223	AK	AP001	1.72 Hex	6.5 Hex	

For full details of assembly procedures, go to [www.coax-connectors.com/ap](http://www.coax-connectors.com/ap)

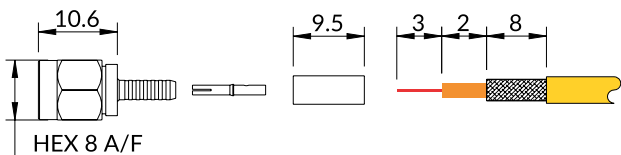

## RP straight crimp jack.

Reverse polarity cable mounted jacks are available either for free cable or bulkhead mounting.

Reverse polarity connectors are ideal for use where it is necessary to differentiate between different lines and avoid incorrect connections.

Centre contact and body are gold plated except where otherwise stated.



Figure 1

Figure 2

Part Number	Cable Types (for more see appendix)	Cable Group	Assembly Procedure	Centre Contact	Outer Contact	Features
31-054-A3-AD	RG174, RG188, RG316, Times LMR®100	AD	AP001	1.07 Sq	3.25 Hex	Figure 1, Nickel plated body
31-054-A3-AH	RG58, RG141, Times LMR®195	AH	AP001	1.72 Hex	5.41 Hex	Figure 1, Nickel plated body
31-054-D3-AD	RG174, RG188, RG316, Times LMR®100	AD	AP001	1.07 Sq	3.25 Hex	Figure 1
31-054-D3-AH	RG58, RG141, Times LMR®195	AH	AP001	1.72 Hex	5.41 Hex	Figure 1, Rear mount
31-254-1-D3-AH	RG58, RG141, Times LMR®195	AH	AP001	1.72 Hex	5.41 Hex	Figure 2 Rear mount
31-254-D3-AD	RG174, RG188, RG316, Times LMR®100	AD	AP001	1.07 Sq	3.25 Hex	Figure 2

For full details of assembly procedures, go to [www.coax-connectors.com/ap](http://www.coax-connectors.com/ap)

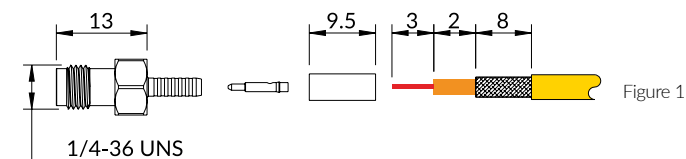

Figure 1

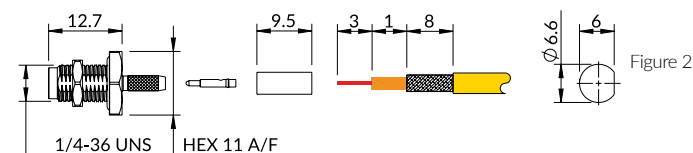

Figure 2





SMB	Page
Straight cable plug	138
Right angle cable plug	139
Straight jack	140
Straight bulkhead jack	141
Right angle bulkhead jack	141
Straight 2 & 4 hole flange mount jack	142
Straight PCB jack	143
Right angle PCB	144
Adaptors	145

## SMB connectors.

SMB 50 ohm sub-miniature series are a widely used general purpose RF connector meeting IEC 60169-10. Smaller than SMA they feature a snap together coupling and are suitable for applications up to 4GHz.

SMB have a gold plated centre and outer contact and are suited to applications in all industries. In common with the similar screw coupled SMC series, the centre contacts of SMB are reversed when compared with the larger SMA, with the plug having the female contact.

### Key Features:

Small size

Simple snap on coupling

DC to 4GHz frequency range



### New connectors.

We are regularly designing new connectors to enhance our range, if you can not find what you need, please contact us.

## Specification.

Electrical Specification		Environmental Specification	
Impedance	50 ohm	Operation temperature	-55 to +155 Deg C
Frequency Range	Up to 4GHz	IP Rating (Mated)	IP40
Dielectric Withstand Voltage	500 Veff		
Insulation Resistance	1000 M-ohm		
Mechanical Specification		Materials	
Design Standard	IEC 60169-10	Centre Contact	Phosphur Bronze/ Beryllium Copper
ROHS Compliant	Yes	Outer Contact	Phosphur Bronze/ Beryllium Copper/Brass
Mating Cycles	500	Insulator	PTFE
Contact Retention	10N min		
Mating Force	62N max	Centre Contact Plating	Gold
Un-coupling Force	62N max	Outer Contact Plating	Gold/Nickel
The above values are typical. Please check product data sheets for full details - see <a href="http://www.coax-connectors.com">www.coax-connectors.com</a> or call +44(0)20 8538 9090			

## SMB 50 ohm interface.

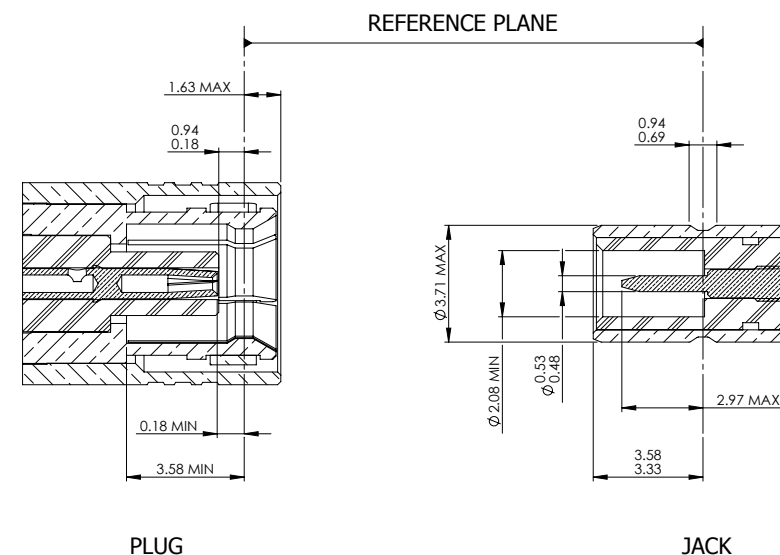

## Straight cable plug.

SMB cable plugs fit a range of standard cables. Centre contacts are crimped and the outer conductor is hexagon crimped (except direct solder version)

Inner and outer contacts are gold plated together with the outer body parts.

Part Number	Cable Types (for more see appendix)	$\Omega$	Cable Group	Assembly Procedure	Centre Contact	Outer Contact	Features
32-005-D3-AA	RG178, RG196	50	AA	AP020	0.95Sq	3.25 Hex	5 part, outline below does not show all parts
32-005-D3-AB	RG179, RG187, Belden179DT	75	AB	AP020	Indent	3.25 Hex	
32-005-D3-AD	See appendix for details on pages 198-203	50	AD	AP020	Indent	3.25 Hex	
32-005-D3-AE	RD316, RD188	50	AE	AP020	Indent	3.84 Hex	
32-005-D3-AH	RG58, RG141, Times LMR@195	50	AH	AP020	Indent	5.41 Hex	
32-005-D3-BG	RA8000	75	BG	AP020	Indent	3.25 Hex	
32-010-D0-BD	BT3002, TZC75024	75	BD	AP020	Indent	4.52 Hex	
32-014-D3-HC	RG401 (.250")	50	HC	AP033	Solder	Solder	For direct solder to Semi-Rigid cable, outline not show

For full details of assembly procedures, go to [www.coax-connectors.com/ap](http://www.coax-connectors.com/ap)

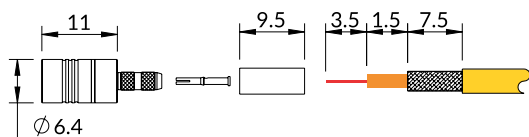

## Right angle cable plug.

Right angle cable plugs are available in various styles. A simple to assemble solder clamp version is available for RG178 and similar cables, the other variants use hexagon crimped outer conductors.

Two options are available for the soldering of the centre contact. The standard design is soldered through an aperture in the square body which is then covered by a cap. The 'capless' version is soldered through a cut-away recess in the extended rear body which is then covered by a flared crimp sleeve. The 'capless' version features a swept centre contact for improved RF performance.

Inner and outer contacts are gold plated together with the outer body parts.

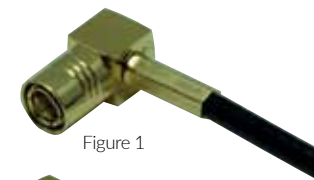

Figure 1

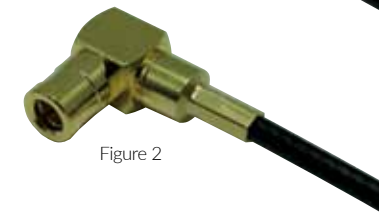

Figure 2

Part Number	Cable Types (for more see appendix)	$\Omega$	Cable Group	Assembly Procedure	Centre Contact	Outer Contact	Features
32-101-D3-AA	RG178, RG196	50	AA	AP040	Solder	Clamp	Not shown
32-105-D3-AB	RG179, RG187, Belden179DT	75	AB	AP017	Solder	3.25 Hex	Figure 2 Capless
32-105-D3-AD	See appendix for details on pages 198-203	50	AD	AP017	Solder	3.25 Hex	Figure 1
32-105-D3-AE	RD316, RD188	50	AE	AP017	Solder	3.84 Hex	Figure 1
32-105-D3-BD	BT3002, TZC75024	75	BD	AP040	Solder	4.52 Hex	Figure 2 Capless
32-105-D3-BG	RA8000	75	BG	AP017	Solder	3.25 Hex	Figure 1
32-105-D6-AC	RD179	75	AC	AP017	Solder	3.84 Hex	Figure 1

For full details of assembly procedures, go to [www.coax-connectors.com/ap](http://www.coax-connectors.com/ap)

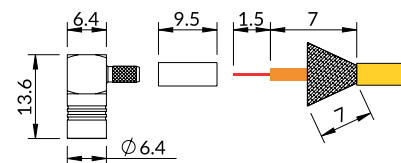

Figure 1

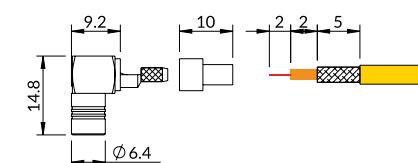

Figure 2

## Straight jack.

SMB cable jacks fit a range of standard cables. Centre contacts are indent crimped and the outer conductor is hexagon crimped.

Inner contacts are gold plated, outer body parts are either gold or nickel depending on part number selected.

Part Number	Cable Types (for more see appendix)	$\Omega$	Cable Group	Assembly Procedure	Centre Contact	Outer Contact	Features
32-054-B3-AB	RG179, RG187, Belden179DT	75	AB	AP020	Indent	3.25 Hex	Nickel plated body
32-054-B3-AD	See appendix for details on pages 198-203	50	AD	AP020	Indent	3.25 Hex	Nickel plated body
32-054-D3-AE	RD316, RD188	50	AE	AP020	Indent	3.84 Hex	Gold plated body

For full details of assembly procedures, go to [www.coax-connectors.com/ap](http://www.coax-connectors.com/ap)

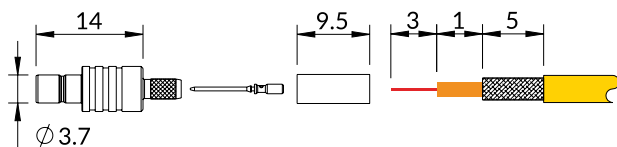

## Straight bulkhead rear mount jack.

Bulkhead cable jacks fit a range of standard cables. Centre contacts are indent or square crimped and the outer conductor is hexagon crimped.

All bulkhead connectors are supplied complete with fixing nut and washer.

Inner contacts are gold plated, outer body parts are either gold or nickel depending on part number selected.

Part Number	Cable Types (for more see appendix)	$\Omega$	Cable Group	Assembly Procedure	Centre Contact	Outer Contact	Features
32-254-A3-AD	See appendix for details on pages 198-203	50	AD	AP020	Indent	3.25 Hex	Nickel plated body
32-254-D3-AA	RG178, RG196	50	AA	AP001	1.07 Sq	3.25 Hex	
32-254-D3-AB	RG179, RG187, Belden179DT	75	AB	AP001	1.07 Sq	3.25 Hex	

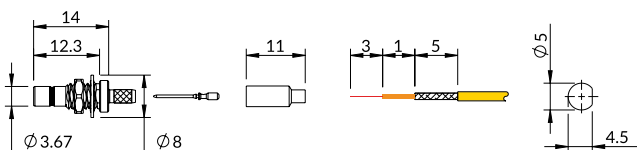

## Right angle bulkhead jack.

Right angle bulkhead cable jacks have a soldered centre conductor, the outer conductor is hexagon crimped.

All bulkhead connectors are supplied complete with fixing nut and washer.

Inner and outer contacts are gold plated together with the outer body parts.

Part Number	Cable Types (for more see appendix)	Cable Group	Assembly Procedure	Centre Contact	Outer Contact	Features
32-271-D3-AD	RG174, RG188, RG316, Times LMR@100	AD	AP017	Solder	3.25 Hex	

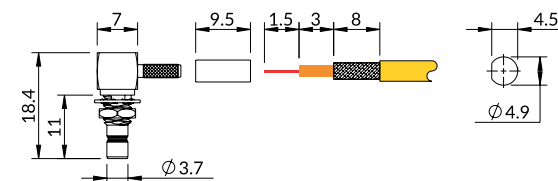

## Right angle bulkhead jack IP68 sealed.

Right angle bulkhead jacks sealed to IP68 in both mated and unmated condition. Tested to withstand immersion to 50 metres.

All bulkhead connectors are supplied complete with fixing nut and washer.

Inner and outer contacts are gold plated together with the outer body parts.

Part Number	Cable Types (for more see appendix)	Cable Group	Assembly Procedure	Centre Contact	Outer Contact	Features
32-271-1-D3-AD	See appendix for details on pages 198-203	AD	AP017	Solder	3.25 Hex	IP68 sealed unmated

For full details of assembly procedures, go to [www.coax-connectors.com/ap](http://www.coax-connectors.com/ap)

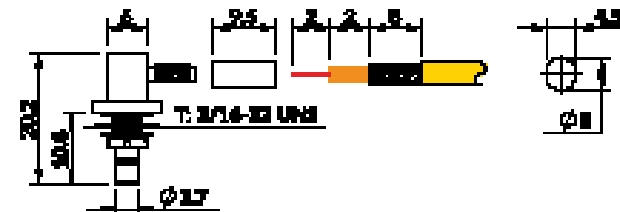

IP68

## Straight 2 & 4 hole flange mount jack.



Figure 1



Figure 2

Flange mount jacks are available for either 2 or 4 hole fixing.

The 4 hole version has a 0.7mm slotted centre contact and the 2 hole version a solder tab.

Centre contact and bodies are gold plated.

Part Number	Centre Contact	Features
32-369-D3	Solder	Figure 1, 2 hole flange Solder tab contact
32-371-D3	Solder	Figure 2, 4 hole flange 0.7mm slotted solder contact

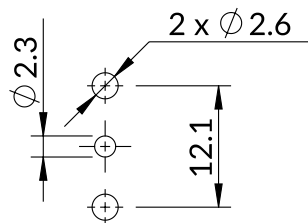
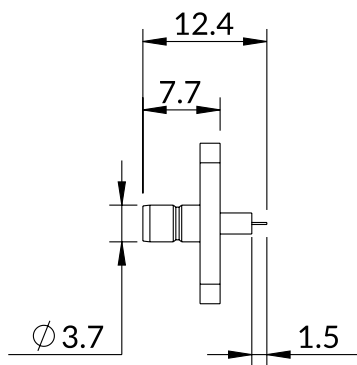

Figure 1

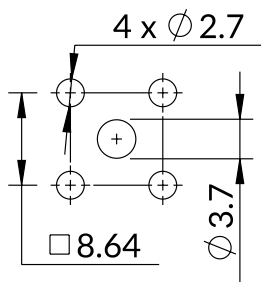
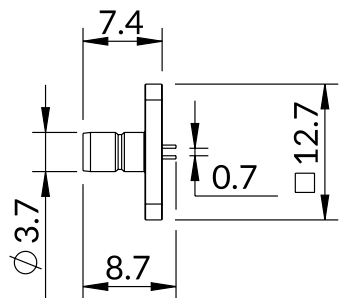

Figure 2

## Straight PCB jack.

PCB through hole solder jacks are available in both 50 and 75 ohm variants and a different body styles.

Bulkhead mounted versions are supplied complete with fixing nut and lock washer.

Centre and outer contact plating are gold plated unless otherwise shown.

Part Number	Centre Contact	Outer Contact	Features
32-450-B3	Solder	Solder	Figure 1 - 50 ohm tapered base - Nickel plated body
32-450-D6	Solder	Solder	Figure 2 - 75 ohm flat base
32-454-D0	Solder	Solder	Figure 3 - 50 ohm - Bulkhead



Figure 1

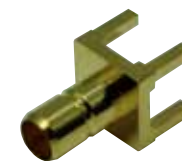

Figure 2



Figure 3

Figure 1

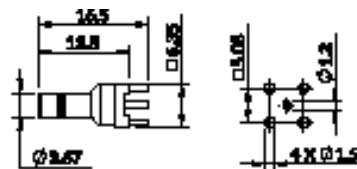

Figure 2

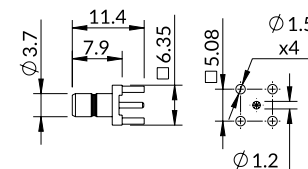
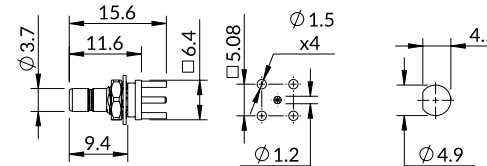

Figure 3



## Right angle PCB.

Right angle through hole soldered PCB connectors are available for either stand alone or bulkhead mounting.

Bulkhead mounted versions are supplied complete with fixing nut and lock washer.

Centre and outer contacts are gold plated.



Figure 1

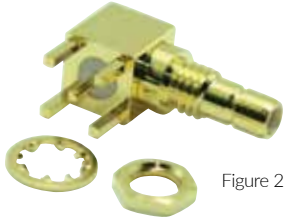

Figure 2

Part Number	Centre Contact	Outer Contact	Features
32-465-D0	Solder	Solder	Figure 1
32-470-D3	Solder	Solder	Figure 2 Bulkhead Mounting

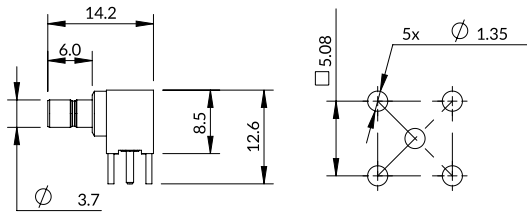

Figure 1

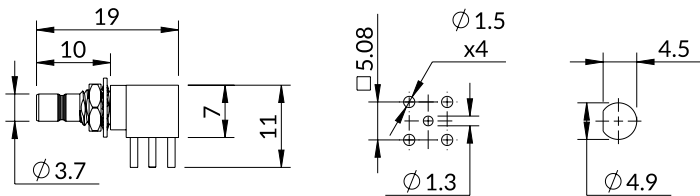

Figure 2

## Adaptors.

Adaptors in a range of configurations for connection within the series of SMB connectors. For connecting SMB to other coaxial connector types, see our range of Inter Series Adaptors.

All adaptors have gold plated centre contacts and bodies.

Figure 1



Part Number	Configuration			Features
32-501-D3	Jack	Jack	Jack	Figure 1, Bulkhead mount
32-514-D3	Plug	Plug	Plug	Figure 2
32-522-D3	Jack	Jack	Jack	Please contact COAX for details
32-523-D3	Jack	Plug	Jack	Please contact COAX for details



Figure 2

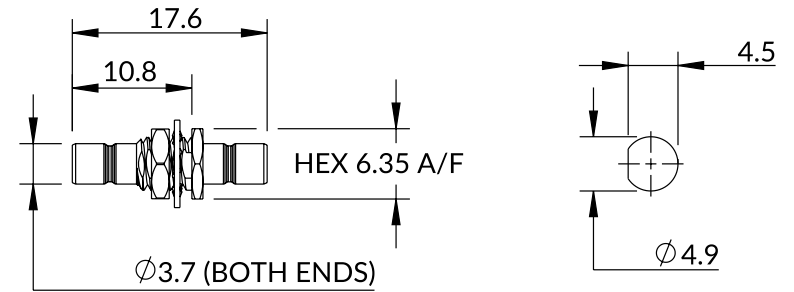

Figure 1

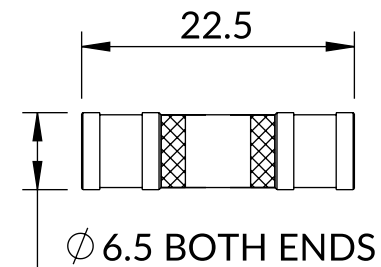
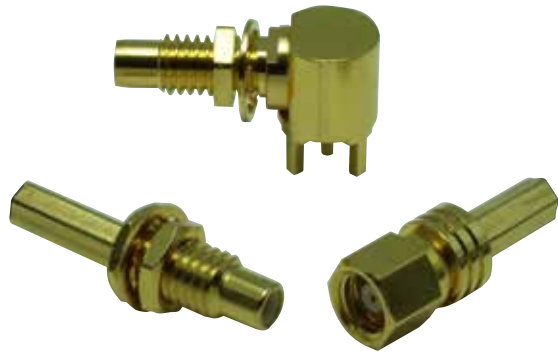

Figure 2



SMC	Page
Straight & right angle cable plug	148
Right angle PCB bulk head jack	148
Straight jack	149

## SMC connectors.

SMC 50 ohm sub-miniature series are a widely used general purpose RF connector meeting IEC 60169-10. Smaller than SMA they feature a screw coupling and are suitable for applications up to 4GHz.

SMC have a gold plated centre and outer contact and are suited to applications in all industries. In common with the similar snap together coupled SMB series, the centre contacts of SMC are reversed when compared with the larger SMA, with the plug having the female contact.

### Key Features:

- Small size
- Screw coupling
- DC to 4GHz frequency range



### New connectors.

We are regularly designing new connectors to enhance our range, if you can not find what you need, please contact us.

## Specification.

Electrical Specification		Environmental Specification	
Impedance	50 ohm	Operation temperature	-55 to +155 Deg C
Frequency Range	Up to 4GHz	IP Rating (Mated)	IP44
Dielectric Withstand Voltage	500 Veff		
Insulation Resistance	1000 M-ohm		
Mechanical Specification		Materials	
Design Standard	IEC 60169-9	Centre Contact	Phosphor Bronze/ Beryllium Copper
ROHS Compliant	Yes	Outer Contact	Brass
Mating Cycles	500	Insulator	PTFE
Contact Retention	18N min	Coupling Nut	Brass
Coupling Nut Torque	11.3Ncm max	Centre Contact Plating	Gold
		Outer Contact Plating	Gold

The above values are typical. Please check product data sheets for full details - see [www.coax-connectors.com](http://www.coax-connectors.com) or call +44(0)20 8538 9090

## SMC 50 ohm interface.

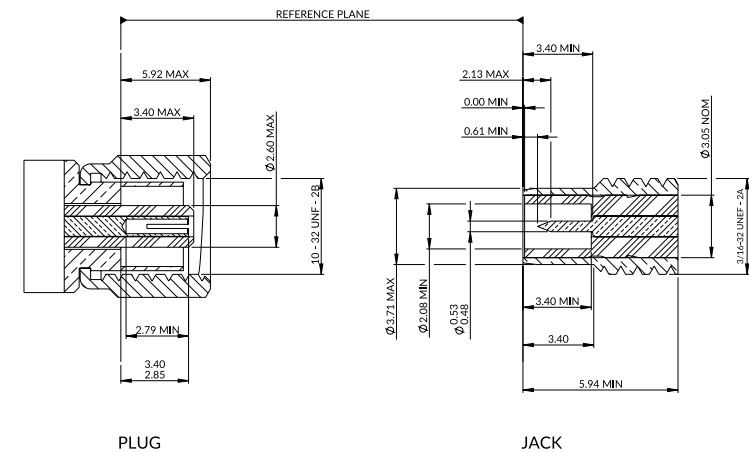



## Straight & right angle cable plug.

A selection of cable plugs are available in both straight and right angle styles. Termination is either solder, crimp or clamp and suitable tooling can be found in the Accessories & Tooling section of this catalogue.

Centre and outer contacts are gold plated.

Part Number	Cable Types (for more see appendix)	Cable Group	Assembly Procedure	Centre Contact	Outer Contact	Features
34-001-D3-AH	RG58, RG141, Times LMR®195	AH		Solder	Clamp	Not shown
34-005-C3-AD	See appendix for details on pages 198-203	AD	AP020	Indent	3.25 Hex	
34-005-D3-AD	See appendix for details on pages 198-203	AD	AP020	Indent	3.25 Hex	
34-005-D3-AA	RG178, RG196	AA	AP001	1.07 Sq	3.25 Hex	
34-105-D3-AD	See appendix for details on pages 198-203	AD	AP017	Solder	3.25 Hex	Right Angle version not shown. Contact COAX for outline

For full details of assembly procedures, go to [www.coax-connectors.com/ap](http://www.coax-connectors.com/ap)

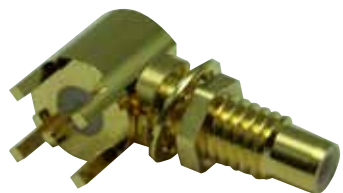
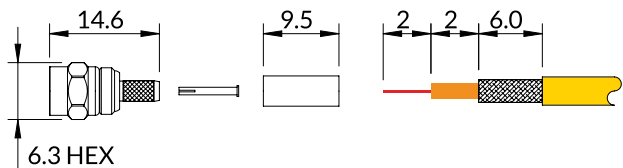

## Right angle PCB bulkhead jack.

Part Number	Centre Contact	Outer Contact	Features
34-468-D3	Solder	Solder	

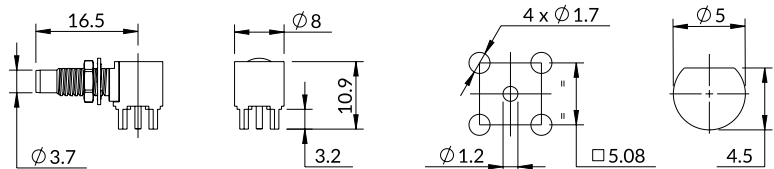

## Straight jack.

A selection of jacks are available for both cable fitting or for panel mounting. Panel mount versions include 4 hole flange mount and rear mount D hole fitting. Cable mount style is terminated using centre contact indent crimp and hex crimped outer.

Suitable tooling can be found in the Accessories & Tooling section of this catalogue.

Centre contact and outer body parts are gold plated.



Figure 1



Figure 2



Figure 3

Part Number	Cable Types (for more see appendix)	Cable Group	Assembly Procedure	Centre Contact	Outer Contact	Features
34-254-D3-AD	See appendix for details on pages 198-203	AD	AP020	Indent Crimp	3.25 Hex	Rear mount bulkhead. Cable fitting, Figure 1
34-350-D3	N/A		N/A	Solder		Rear mount bulkhead. Solder bucket, Figure 2
34-371-D3	N/A		N/A	Solder Bucket		4 hole flange mount, Figure 3

For full details of assembly procedures, go to [www.coax-connectors.com/ap](http://www.coax-connectors.com/ap)

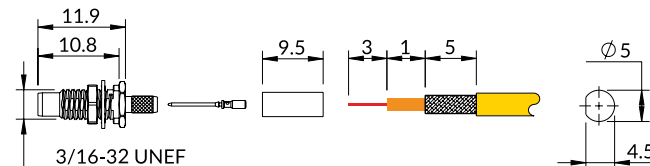

Figure 1

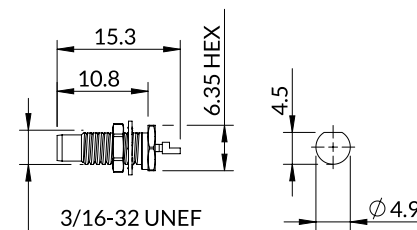

Figure 2

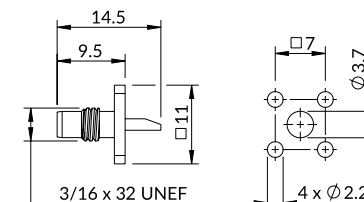

Figure 3



# Type 43 (SMZ) connectors.

Type 43 (SMZ) connectors are extensively used on 75 ohm communication systems and have become the recognised standard in telecommunications in many parts of the world.

Designed around the requirements of BS9210 F0022, these connectors are designed for field installation and feature a secure latching system to prevent accidental disconnection.

Type 43 (SMZ) Connectors are available in 3 package sizes, Standard, HDC (high density) & UHDC (ultra high density).

Whilst all configurations have the same interface dimensions and are intermateable, the outer body sizes vary, UHDC being the smallest to facilitate a closer packing density on the distribution frame.

## Key Features:

- Simple and secure latching
- Full crimp terminations
- Fits to standard telecom cables
- DDF mounting with U link connections

Type 43 (SMZ)	Page
Straight DDF mount cable plug	152
Straight cable socket	153
Right angle cable socket	154
Adaptor 76A	154
Right angle PCB plug	155
U Link - 13A	155
HDC 43	
Straight DFF mount cable plug	156
Straight cable socket	157
HDC U Link	160
UHDC 43	
Straight DFF mount cable plug	158
Straight cable socket	159
UHDC U Link	160

## Specification.

Electrical Specification		Environmental Specification	
Impedance	50 ohm	Operation temperature	-55 to +155 Deg C
Frequency Range	Up to 3GHz	IP Rating (Mated)	N/A
Dielectric Withstand Voltage	1500 Veff		
Insulation Resistance	5000 M-ohm		
Mechanical Specification		Materials	
Design Standard	BS 9210F0022 (BT RC8003)	Centre Contact	Phosphur Bronze/ Beryllium Copper
ROHS Compliant	Yes	Outer Contact	Phosphur Bronze/ Beryllium Copper/Brass
Mating Cycles	250	Insulator	PTFE
Contact Retention	22N min	Body	Brass
Mating Force	60N max	Centre Contact Plating	Gold
Un-coupling Force	8-60N max	Outer Contact Plating	Gold
The above values are typical. Please check product data sheets for full details - see <a href="http://www.coax-connectors.com">www.coax-connectors.com</a> or call +44(0)20 8538 9090			

## Type 43 (SMZ) interface.

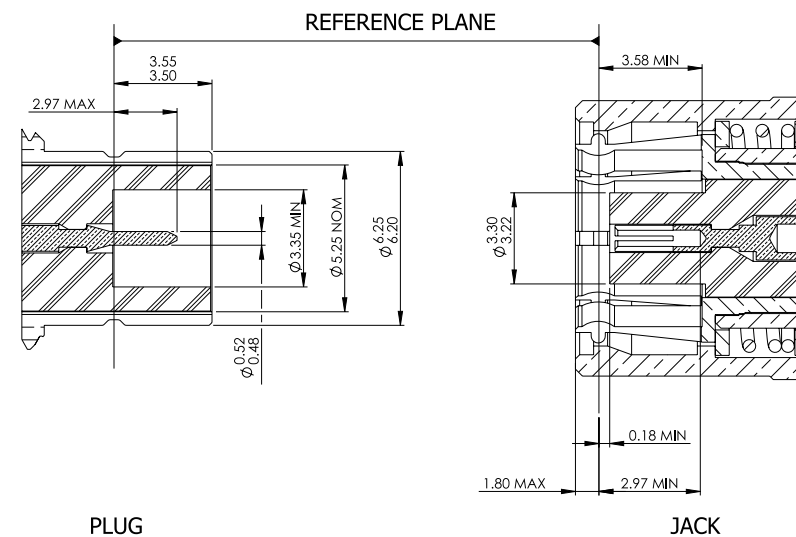

## Straight DDF mount cable plug.

Type 43 DDF plugs are designed to fit to standard BT distribution frames 6000 & 6003. The white plastic C clip snaps into the mounting block allowing a small amount of float to aid alignment when fitting U links.

Centre and outer contact are gold plated and terminated by crimping. Suitable tooling for crimping and extraction from mounting blocks can be found in the Accessories & Tooling section of this catalogue.



Part Number	Cable Types (for more see appendix)	Cable Group	Assembly Procedure	Centre Contact	Outer Contact	Telecom Industry Designation
43-011-D6-AB	RG179, RG187, Belden179DT	AB	AP023	0.95 Sq	3.25 Hex	Plug 43/4GTIS
43-011-D6-BD	BT3002, TZC75024	BD	AP023	0.95 Sq	4.52 Hex	Plug 43/5GTIS
43-011-D6-BE	BT5000, RA5000	BE	AP022	0.95 Sq	8.23 Hex	Plug 43/6GTIS
43-011-D6-BF	BT7000, RA7000	BF	AP023	0.95 Sq	5.18 Hex	Plug 43/7GTIS
43-011-D6-BG	RA8000	BG	AP023	0.95 Sq	3.25 Hex	Plug 43/8GTIS
43-011-D6-BI	1.6 mm Diameter Micro Coax	BI	AP024	0.95 Sq	3.25 Hex	
43-011-D6-BJ	2.2 mm Diameter Micro Coax	BJ	AP024	0.95 Sq	3.25 Hex	

For full details of assembly procedures, go to [www.coax-connectors.com/ap](http://www.coax-connectors.com/ap)

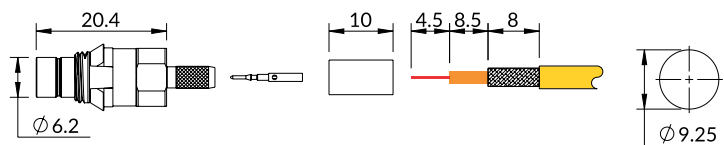

## Straight cable socket.

Standard Type 43 sockets provide a secure, positive lock when mated with a compatible plug and are identified with a white band on the body.

The socket locks to the mating plug by sliding the front sleeve forward, and when the sleeve is released they are locked, and can only be uncoupled by sliding back the sleeve.

Space permitting, Type 43 sockets will fit to any HDC or UHDC plug in the Type 43 range.

Centre and outer contact are gold plated and terminated by crimping. Suitable tooling can be found in the Accessories & Tooling section of this catalogue.



Part Number	Cable Types (for more see appendix)	Cable Group	Assembly Procedure	Centre Contact	Outer Contact	Telecom Industry Designation
43-060-D6-AB	RG179, RG187, Belden179DT	AB	AP023	0.95 Sq	3.25 Hex	Socket 43/4FS
43-060-D6-BD	BT3002, TZC75024	BD	AP023	0.95 Sq	4.52 Hex	Socket 43/5FS
43-060-D6-BE	BT5000, RA5000	BE	AP022	0.95 Sq	8.23 Hex	Socket 43/6FS
43-060-D6-BF	BT7000, RA7000	BF	AP023	0.95 Sq	5.18 Hex	Socket 43/7FS
43-060-D6-BG	BT7000, RA7000	BF	AP023	0.95 Sq	5.18 Hex	Socket 43/8FS
43-060-D6-BI	1.6 mm Diameter Micro Coax	BI	AP024	0.95 Sq	3.25 Hex	
43-060-D6-BJ	2.2 mm Diameter Micro Coax	BJ	AP024	0.95 Sq	3.25 Hex	

For full details of assembly procedures, go to [www.coax-connectors.com/ap](http://www.coax-connectors.com/ap)

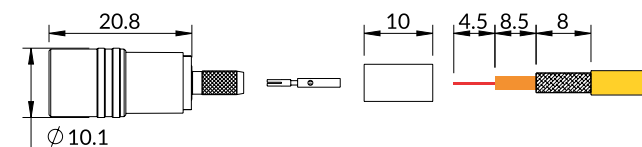



## Right angle cable socket.

This socket is connected to cable by soldering the centre contact through an aperture in the square body and crimping the outer conductor. The aperture is sealed with a press in cap to complete the assembly.

Simple and robust connection is made by sliding the outer sleeve back or forward to connect and dis-connect from the mating plug.

Centre and outer contacts are gold plated, outer body parts are nickel plated.

Part Number	Cable Types (for more see appendix)	Cable Group	Assembly Procedure	Centre Contact	Outer Contact	Telecom Industry Designation
43-105-D6-AB	RG179, RG187, Belden179DT	AB	AP017	Solder	3.25 Hex	Socket 43/4C
43-105-D6-AI	RG59, RG62, URM70	AI	AP017	Solder	6.5 Hex	
43-105-D6-BD	BT3002, TZC75024	BD	AP017	Solder	4.52 Hex	Socket 43/5C
43-105-D6-BE	BT5000, RA5000	BE	AP017	Solder	8.23 Hex	Socket 43/6C
43-105-D6-BF	BT7000, RA7000	BF	AP017	0.95 Sq	5.18 Hex	Socket 43/7C

For full details of assembly procedures, go to [www.coax-connectors.com/ap](http://www.coax-connectors.com/ap)

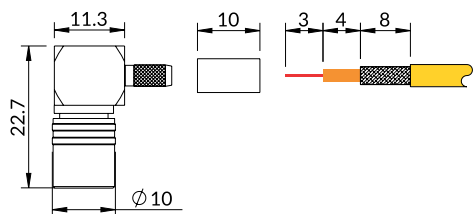

## Adaptor 76A.

Adaptor for connecting between a BNC jack and a Type 43 socket. Centre and outer contacts are gold plated, the body is nickel plated. See our Inter-Series Adaptors section for a full range of adaptors.

Part Number	Telecom Industry Designation
43-76A	Adaptor 76A

## Right angle PCB plug.

PCB through hole solder right angle plug. Inner contact and outer body parts are gold plated.

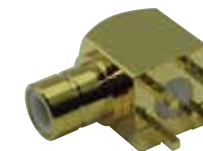

Part Number	Centre Contact	Outer Contact	Telecom Industry Designation
43-415-D3	Solder	Solder	Plug 43/1E

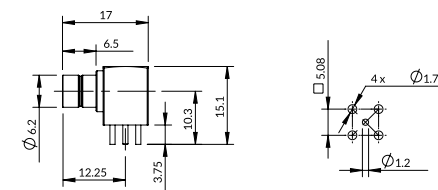

## U Link - 13A.

Type 43 U link used in conjunction with cable plugs mounted on a 12.7mm pitch distribution frame. The U link makes a direct connection between the 2 adjacent ports.

Centre and outer contacts are gold plated, the body is nickel plated.



Part Number	Telecom Industry Designation
43-528-D6	Link Coaxial 13A

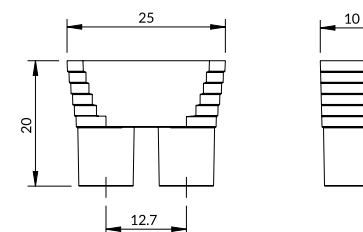



## Straight DDF mount cable plug.

HDC 43 DDF plugs are designed to fit to standard HDC distribution frames with B2 mounting blocks. The blue plastic C clip snaps into the mounting block allowing a small amount of float to aid alignment when fitting U links.

Centre and outer contact are gold plated and terminated by crimping. Suitable tooling for crimping and extraction from mounting blocks can be found in the Accessories & Tooling section of this catalogue.

Part Number	Cable Types (for more see appendix)	Cable Group	Assembly Procedure	Centre Contact	Outer Contact	Telecom Industry Designation
43-012-D6-AB	RG179,RG187, Belden179DT	AB	AP023	0.95 Sq	3.25 Hex	Plug HDC43/4GTIS
43-012-D6-AC	RD 179	AC	AP023	0.95 Sq	3.84 Hex	
43-012-D6-BD	BT3002,TZC75024	BD	AP023	0.95 Sq	4.52 Hex	Plug HDC43/5GTIS
43-012-D6-BF	BT7000,RA7000	BF	AP023	0.95 Sq	5.18 Hex	Plug HDC43/7GTIS
43-012-D6-BG	RA8000	BG	AP023	0.95 Sq	3.25 Hex	Plug HDC43/8GTIS
43-012-D6-BI	1.6 mm Diameter Micro Coax	BI	AP024	0.95 Sq	3.25 Hex	
43-012-D6-BJ	2.2 mm Diameter Micro Coax	BJ	AP024	0.95 Sq	3.25 Hex	

For full details of assembly procedures, go to [www.coax-connectors.com/ap](http://www.coax-connectors.com/ap)

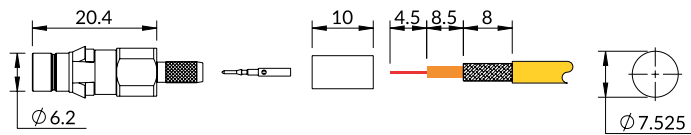

## Straight cable socket.

HDC 43 sockets provide a secure, positive lock when mated with an equivalent HDC plug and are identified with a blue band on the body.

The socket locks to the mating plug by sliding the front sleeve forward, when the sleeve is released the plug and socket are locked and can only be uncoupled by sliding the sleeve back.

Space permitting, HDC sockets will fit to any plug in the Type 43 range.

Centre and outer contact are gold plated and terminated by crimping. Suitable tooling can be found in the Accessories & Tooling section of this catalogue.



Part Number	Cable Types (for more see appendix)	Cable Group	Assembly Procedure	Centre Contact	Outer Contact	Telecom Industry Designation
43-061-D6-AB	RG179,RG187,Belden179DT	AB	AP023	0.95 Sq	3.25 Hex	Socket HDC43/4FS
43-061-D6-BD	BT3002,TZC75024	BD	AP023	0.95 Sq	4.52 Hex	Socket HDC43/5FS
43-061-D6-BF	BT7000,RA7000	BF	AP023	0.95 Sq	5.18 Hex	Socket HDC43/7FS
43-061-D6-BG	RA8000	BG	AP023	0.95 Sq	3.25 Hex	Socket HDC43/8FS
43-061-D6-BI	1.6 mm Diameter Micro Coax	BI	AP024	0.95 Sq	3.25 Hex	
43-061-D6-BJ	2.2 mm Diameter Micro Coax	BJ	AP024	0.95 Sq	3.25 Hex	

For full details of assembly procedures, go to [www.coax-connectors.com/ap](http://www.coax-connectors.com/ap)

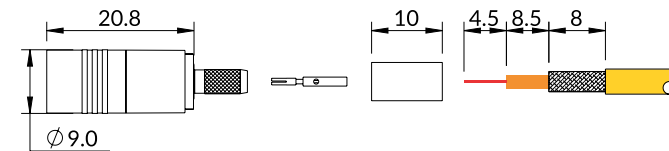

## Straight DDF mount cable plug.

UHDC 43 DDF plugs are designed to fit to UHDC mounting blocks with a hole spacing of 9mm. The purple plastic C clip snaps into the mounting block allowing a small amount of float to aid alignment when fitting U links.

When fitted to UHDC blocks a significant space saving can be achieved when compared to standard BT plugs or HDC plugs.

Centre and outer contact are gold plated and terminated by crimping. Suitable tooling for crimping and extraction from mounting blocks can be found in the Accessories & Tooling section of this catalogue.

Part Number	Cable Types (for more see appendix)	Cable Group	Assembly Procedure	Centre Contact	Outer Contact	Telecom Industry Designation
43-014-D6-AB	RG179, RG187, Belden179DT	AB	AP023	0.95 Sq	3.25 Hex	Plug UHDC43/4GTIS
43-014-D6-BD	BT3002, TZC75024	BD	AP023	0.95 Sq	4.52 Hex	Plug UHDC43/5GTIS

For full details of assembly procedures, go to [www.coax-connectors.com/ap](http://www.coax-connectors.com/ap)

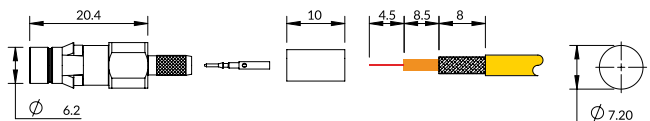

## Straight cable socket.

UHDC 43 sockets provide a secure, positive lock when mated with a compatible plug and are identified with a purple band on the body.

The socket locks to the mating plug by sliding the front sleeve forward, and when the sleeve is released they are locked, and can only be uncoupled by sliding back the sleeve.

UHDC sockets will fit to any plug in the Type 43 range.

Centre and outer contact are gold plated and terminated by crimping. Suitable tooling can be found in the Accessories & Tooling section of this catalogue.



Part Number	Cable Types (for more see appendix)	Cable Group	Assembly Procedure	Centre Contact	Outer Contact	Telecom Industry Designation
43-062-D6-AB	RG179, RG187, Belden179DT	AB	AP023	0.95 Sq	3.25 Hex	Socket UHDC43/4FS
43-062-D6-BD	BT3002, TZC75024	BD	AP023	0.95 Sq	4.52 Hex	Socket UHDC43/5FS
43-062-D6-BF	BT7000, RA7000	BF	AP023	0.95 Sq	5.18 Hex	Socket UHDC43/7FS
43-062-D6-BG	RA8000	BG	AP023	0.95 Sq	3.25 Hex	Socket UHDC43/8FS
43-062-D6-BI	1.6 mm Diameter Micro Coax	BI	AP024	0.95 Sq	3.25 Hex	
43-062-D6-BJ	2.2 mm Diameter Micro Coax	BJ	AP024	0.95 Sq	3.25 Hex	

For full details of assembly procedures, go to [www.coax-connectors.com/ap](http://www.coax-connectors.com/ap)

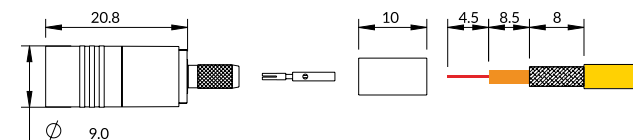



## HDC & UHDC U link.



Figure 1



Figure 2



Figure 3



Figure 4

These U links are designed to fit to a pair of connectors mounted on a suitable mounting block. HDC U links connect plugs mounted on a 10mm pitch whereas UHDC connect plugs on a 9mm pitch.

Tools for extracting these links can be found in the Accessories and Tooling section of this catalogue.

All U links provide a direct connection between the 2 plug ports. The 10B & 9B are fitted with a 3rd port, which is a plug where the signal is reduced by 30dB to allow for monitoring without affecting the performance of the connected pair.

Due to the tight packing density which can allow 9A & 9B U links to touch when cables on the mating plugs are moved, the bodies of these links are insulated with a purple plastic coating.

Centre contacts are all gold plated, other body parts are nickel plated.

Part Number	Dimension A	Dimension B	Dimension C	Dimension D	Dimension E	Features	Telecom Industry Designation
43-530-D6	10	20	13	17	9	Figure 1	Link Coaxial 10A
43-531-D6	10	20	13	24	9	Figure 2	Link Coaxial 10B
43-532-D6	9	18	13	16	9	Figure 3	Link Coaxial 9A
43-533-D6	9	18	13	24	9	Figure 4	Link Coaxial 9B
43-528-D6	See page 155						Link Coaxial 13A

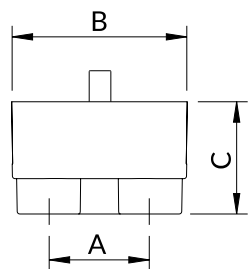

Figure 1 & 3

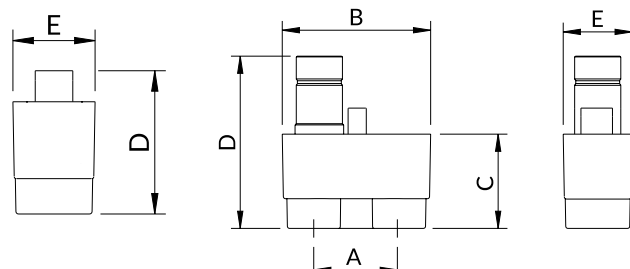

Figure 2 & 4

## SSMZ (Huawei) coax plug.

This plug is designed to fit to coax jacks mounted on Huawei equipment.

Centre and outer conductors are crimped, for suitable tooling see the Accessories & Tooling section of this catalogue.



Part Number	Cable Types (for more see appendix)	Cable Group	Assembly Procedure	Centre Contact	Outer Contact	Features
66-054-B6-BD	BT3002,TZC75024	BD	AP001	0.95 Sq	4.52 Hex	
66-054-B6-BF	BT7000,RA7000	BF	AP001	0.95 Sq	5.18 Hex	

For full details of assembly procedures, go to [www.coax-connectors.com/ap](http://www.coax-connectors.com/ap)

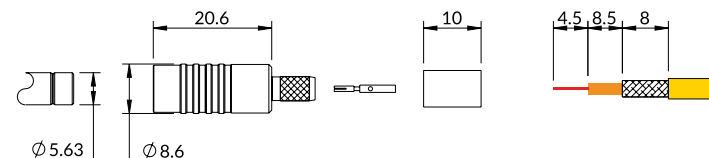



Type 54	Page
Straight cable plug	164
Right angle cable plug	165

## Type 54 (1.0/2.3) connectors.

Type 54 connectors are an evolution of the 75 ohm European standard DIN 1.0/2.3 connectors widely used in telecoms. The Type 54 series was developed in conjunction with British Telecom, as a smaller alternative to the Type 43. A key point of the development was to ensure that installation engineers could terminate both Type 43 & 54 connectors with the same tooling and methods. Crimp tools, cable stripping dimensions together with assembly processes are exactly the same for both series, saving time and capital investment for users of both connector types.

Type 54 are only available as plugs, mating connectors are standard 1.0/2.3. The coupling features a simple and secure push-pull sleeve for ease of connection/disconnection.

### Key Features:

- Utilises Type 43 tooling
- Push-pull coupling
- Full crimp terminations
- Fits standard telecom cables

## Specification.

Electrical Specification		Environmental Specification	
Impedance	75 ohm	Operation Temperature	-55 to +155 Deg C
Frequency Range	Up to 3GHz	IP Rating (Mated)	IP30
Dielectric Withstand Voltage	750 Veff		
Insulation Resistance	200 M-ohm		
Mechanical Specification		Materials	
Design Standard	BT RC9333 (CECC 22 230)	Centre Contact	Beryllium Copper
ROHS Compliant	Yes	Outer Contact	Beryllium Copper
Mating Cycles	250	Insulator	PTFE
Contact Retention	15N min	Coupling Nut	Brass
Mating Force	0.9-1.0N	Centre Contact Plating	Gold
Un-coupling Force	0.9-1.0N	Outer Contact Plating	Gold
The above values are typical. Please check product data sheets for full details - see <a href="http://www.coax-connectors.com">www.coax-connectors.com</a> or call +44(0)20 8538 9090			

## Type 54 (1.0/2.3 75 ohm) interface.

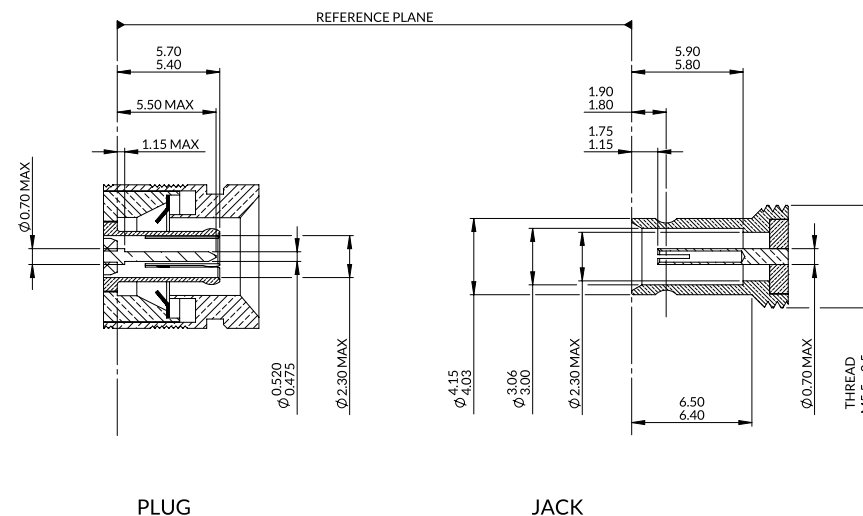

## Straight cable plug.

Type 54 straight 75 ohm plugs are designed to suit a range of standard telecom cables and will mate with any 1.0/2.3 jack.

Both centre and outer conductor are crimped using the same tooling as the Type 43 series to give a high performance, reliable connection.

The push-pull coupling mechanism enables these plugs to be easily connected by simply pushing onto the jack. To uncouple, the sleeve is simply pulled back by hand or with an extractor tool.

Crimp sizes are shown below, suitable crimp and extraction tooling can be found in the Accessories & Tooling section of this catalogue.

Part Number	Cable Types (for more see appendix)	Cable Group	Assembly Procedure	Centre Contact	Outer Contact	Telecom Industry Designation
24-005-B6-BD	BT3002,TZC75024	BD	AP023	0.95 Sq	4.52 Hex	Plug 54/5B
24-005-B6-BF	BT7000,RA7000	BF	AP023	0.95 Sq	5.18 Hex	Plug 54/7B

For full details of assembly procedures, go to [www.coax-connectors.com/ap](http://www.coax-connectors.com/ap)

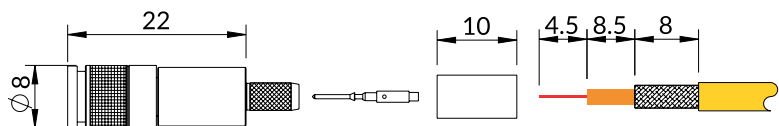

## Right angle cable plug.

Type 54 right angle 75 ohm plugs are designed to suit a range of standard telecom cables and will mate with any 1.0/2.3 jack.

Centre contact is soldered and the outer conductor is crimped using the same tooling and stripping as the Type 43 series to give a high performance, reliable connection.

The push-pull coupling mechanism enables these plugs to be easily connected by simply pushing onto the jack. To uncouple, the sleeve is simply pulled back by hand or with an extractor tool.

Crimp sizes are shown below, suitable crimp and extraction tooling can be found in the Accessories & Tooling section of this catalogue.



Part Number	Cable Types (for more see appendix)	Cable Group	Assembly Procedure	Centre Contact	Outer Contact	Telecom Industry Designation
24-104-B6-BD	BT3002,TZC75024	BD	AP017	Solder	4.52 Hex	Plug 54/5A
24-104-B6-BF	BT7000,RA7000	BF	AP017	Solder	5.18 Hex	Plug 54/7A

For full details of assembly procedures, go to [www.coax-connectors.com/ap](http://www.coax-connectors.com/ap)

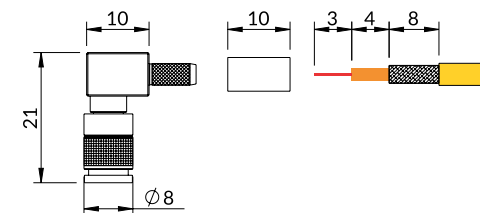



1.0/2.3 - 75 ohm	Page
Straight Push-Pull plug	168
Straight Screw Lock plug	169
Right angle Push-Pull plug	169
Straight crimp cable jack	170
Right angle bulkhead jack	171
Straight PCB jack	172
Right angle PCB jack	171-172
End launch PCB jack	173
Adaptor	173

## DIN 1.0/2.3 connectors.

1.0/2.3 connectors are available in either 50 or True 75 ohm designs.

The 50 ohm variants are widely used throughout Europe being based on the DIN standard 60169-10.

Due to their compact size and the easy to use Push-Pull coupling, the 75 ohm variants have been adopted as standard for use in Broadcast and Telecom industries as a space saving alternative to BNC and other similar series.

The Push-Pull plug allows connectors to be quickly and securely connected by simply pushing onto the mating jack; removal is by sliding back the coupling sleeve with fingers, or a removal tool when space is restricted. Bulkhead mount jacks are fitted with a circular slotted locking nut.

### Key features:

- Small size for high density mounting
- Push-Pull coupling
- Gold plated inner and outer contacts
- Up to 4.5GHz on selected parts



### New connectors.

We are regularly designing new connectors to enhance our range, if you can not find what you need, please contact us.

## Specification.

Electrical Specification		Environmental Specification	
Impedance	75/50 ohm	Operation temperature	-55 to +155 Deg C
Frequency Range	Up to 4.5GHz	IP Rating (Mated)	IP40
Dielectric Withstand Voltage	500 Veff		
Insulation Resistance	1000 M-ohm		
Mechanical Specification		Materials	
Design Standard	IEC 60169-29	Centre Contact	Beryllium Copper
RoHS Compliant	Yes	Outer Contact	Phosphor Bronze /Brass
Mating Cycles	500	Insulator	PTFE
Contact Retention	10N min	Coupling Nut	Brass
Mating Force	<25N max	Centre Contact Plating	Gold
Un-coupling Force	3-25N	Outer Contact Plating	Gold

The above values are typical. Please check product data sheets for full details - see [www.coax-connectors.com](http://www.coax-connectors.com) or call +44(0)20 8538 9090

## DIN 1.0/2.3 Interface.

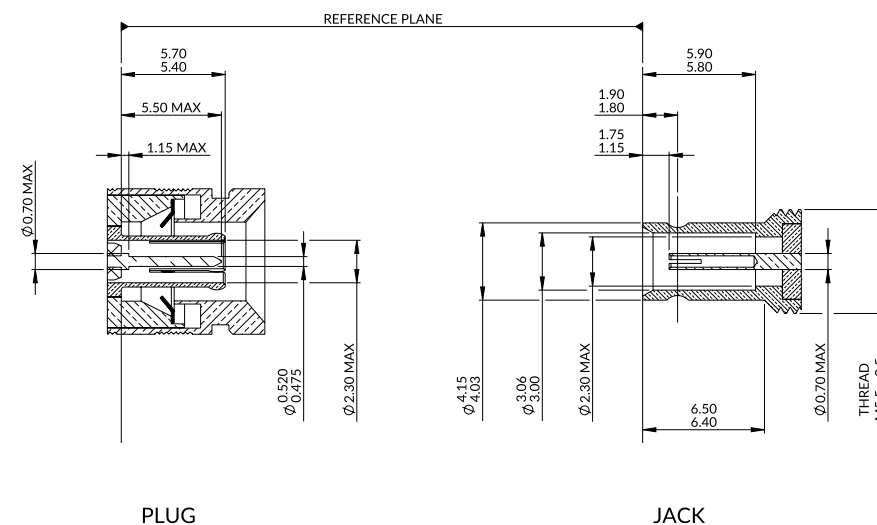



## Straight Push-Pull crimp plug.

Push-Pull crimp plugs are connected by simply pushing onto the mating half, and to remove, pull back on the latching sleeve either by hand, or where space is restricted, by using removal tool (96-1023). This range of plugs includes both standard 50 ohm, plus True 75 ohm options that give excellent low loss performance up to 4.5GHz.

A range of cables for Broadcast and Telecom are covered. Crimped centre contacts and outer contacts are gold plated. Body parts are nickel plated and braid is terminated with a hexagon crimp.

1.0/2.3 crimp plugs are designed for assembly with the COAX crimp alignment tool (100-1023) which overcomes the problem of contacts being misaligned. See Accessories & Tooling section for details.

Part Number	Typical Cable Types (For more see appendix)	Cable Group	Assembly Procedure	Centre Contact	Outer Contact	Features
52-005-B6-AB	RG179, RG187, 179DT	AB	AP026	0.95 Sq	3.25 Hex	*
52-005-B0-AH	RG58, RG141, Times LMR®195	AH	AP026	1.73 Hex	5.41 Hex	50 ohm
52-005-B0-AK	RG223	AK	AP026	1.73 Hex	6.5 Hex	50 ohm
52-005-B6-BC	BT2003, PSF 1/3	BC	AP026	0.95 Sq	3.25 Hex	*
52-005-B6-BD	BT3002, TZC75024	BD	AP026	0.95 Sq	5.18 Hex	*
52-005-B6-BF	BT7000, RA7000	BF	AP026	0.95 Sq	5.18 Hex	*
52-005-B6-BG	RA8000	BG	AP026	0.95 Sq	3.25 Hex	*
52-005-B6-BH	See appendix for details	BH	AP026	0.95 Sq	4.52 Hex	*
52-005-B6-EF	1855A, 1865A	EF	AP026	0.95 Sq	5.41 Hex	
52-005-B6-EF1	1855A, 1865A	EF	AP026	1.07 Sq	4.52 Hex	US Crimp sizes
52-005-B6-EH	Flex3	EH	AP026	1.07 Sq	4.52 Hex	
52-005-B6-FA		FA	AP026	0.95 Sq	5.41 Hex	*
52-005-B6-FB		FB	AP026	0.95 Sq	6.48 Hex	*
52-005-B6-FB1	See appendix for details on pages 198-203	FB	AP026	1.07 Sq	6.48 Hex	US Crimp sizes
52-005--B6-FC		FC	AP026	1.72 Hex	8.23 Hex	*
52-005--B6-FC1		FC	AP026	1.07 Sq	7.06 Hex	US Crimp sizes
52-005-B6-FE	Belden 1505F, Bryant SD50F	FE	AP026	0.95 Sq	6.48 Hex	*

\* These items are also available in bulk packs of 100 pieces.  
For full details of assembly procedures, go to [www.coax-connectors.com/ap](http://www.coax-connectors.com/ap)

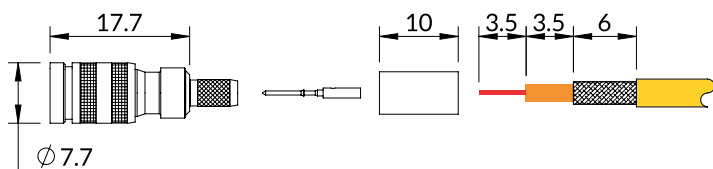

## Straight Screw Lock crimp plug.

Screw Lock crimp plugs are an alternative to Push-Pull and avoid signal loss where vibration is present. The True 75 ohm options give excellent low loss performance up to 4.5GHz.

Crimped centre contacts and outer contacts are gold plated. Body parts are nickel plated and braid is terminated with a hexagon crimp. 1.0/2.3 crimp plugs are designed for assembly with the COAX crimp alignment tool (100-1023) which overcomes the problem of contacts being misaligned. See Accessories & Tooling section for details.

Part Number	Typical Cable Types (For more see appendix)	Cable Group	Assembly Procedure	Centre Contact	Outer Contact	Features
52-005A-B6-AB	RG179, RG187, 179DT	AB	AP026	0.95 Sq	3.25 Hex	
52-005A-B6-FA	See appendix for details on pages 198-203	FA	AP026	0.95 Sq	5.41 Hex	
52-005A-B6-FB	See appendix for details on pages 198-203	FB	AP026	0.95 Sq	6.48 Hex	
52-005A-B6-EF	1855A, 1865A	EF	AP026	0.95 Sq	5.41 Hex	

For full details of assembly procedures, go to [www.coax-connectors.com/ap](http://www.coax-connectors.com/ap)

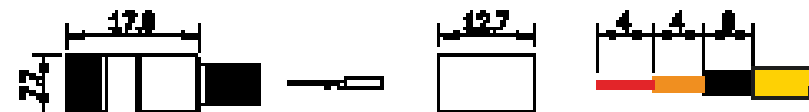

## Right angle Push-Pull crimp plug.

All right angle cable plugs have gold plated inner and outer contacts. The inner centre conductor is soldered through the hole in the rear body, and the outer conductor is crimped.

Plugs can be connected and disconnected by hand, or where space is restricted, a removal tool (96-1023) is available, see Accessories & Tooling section for details.



Part Number	Typical Cable Types (For more see appendix)	Cable Group	Assembly Procedure	Centre Contact	Outer Contact	Features
52-104-B3-BD	BT3002, TZC75024	BD	AP017	Solder	4.52 Hex	
52-104-B6-AB	RG179, RG187,179DT	AB	AP017	Solder	3.25 Hex	
52-104-B6-FA	See appendix for details	FA	AP017	0.95 Sq	5.41 Hex	

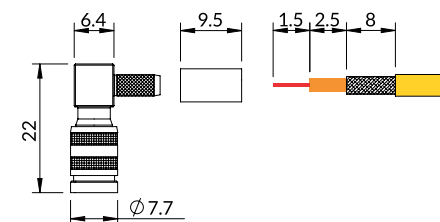

For full details of assembly procedures, go to - [www.coax-connectors.com/ap](http://www.coax-connectors.com/ap)

## Straight crimp bulkhead mount jack.

These cable jacks have crimped inner and outer gold plated contact and body.

The range includes bulkhead mount versions which are supplied complete with a circular slotted lock nut. A tool for tightening this nut (96-1136) can be found in the Accessories & Tooling section of this catalogue.

Part Number	Typical Cable Types (For more see appendix)	Cable Group	Assembly Procedure	Centre Contact	Outer Contact	Features
52-254-D6-AB	RG179, RG187, 179DT	AB	AP037	0.95 Sq	3.25 Hex	4.5 GHz
52-254-D6-BC	BT2003, PSF 1/3	BC	AP026	1.72 Hex	5.41 Hex	4.5 GHz

For full details of assembly procedures, go to [www.coax-connectors.com/ap](http://www.coax-connectors.com/ap)

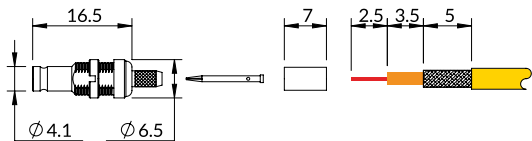

## Straight crimp jack.

These cable jacks have crimped inner and outer gold plated contact and body. Depending on cable type, connectors are available for use up to 4.5GHz

Part Number	Typical Cable Types (For more see appendix)	Cable Group	Assembly Procedure	Centre Contact	Outer Contact	Features
52-054-D6-BD	BT3002, TZC75024	BD	AP026	0.95 Sq	4.52 Hex	1 GHz
52-054-D6-FA	See appendix for details on pages 198-203	FA	AP001	0.95 Sq	5.41 Hex	4.5 GHz
52-054-D6-FB	See appendix for details on pages 198-203	FB	AP001	0.95 Sq	6.48 Hex	4.5 GHz

For full details of assembly procedures, go to [www.coax-connectors.com/ap](http://www.coax-connectors.com/ap)

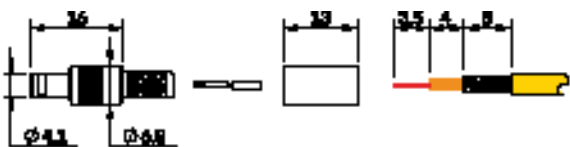

## Right angle bulkhead mount crimp jack.

The body and centre contact of these right angle jacks are gold plated. The inner contact is soldered through an aperture in the square body, the outer contact is crimped.

Bulkhead mount versions are supplied complete with a circular slotted lock nut. A tool for tightening this nut (96-1136) can be found in the Accessories & Tooling section of this catalogue.

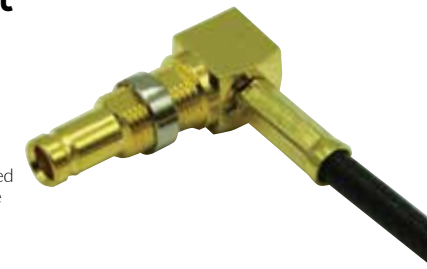

Part Number	Typical Cable Types (For more see appendix)	Cable Group	Assembly Procedure	Centre Contact	Outer Contact	Features
52-271-D3-AB	RG179, RG187, 179DT	AB	AP017	Solder	3.25 Hex	
52-271-D3-BD	BT3002, TZC75024	BD	AP017	Solder	4.52 Hex	

For full details of assembly procedures, go to [www.coax-connectors.com/ap](http://www.coax-connectors.com/ap)

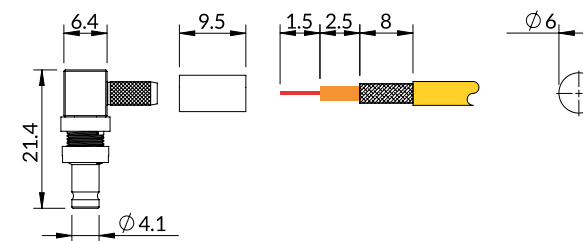

## Twin right angle bulkhead mount PCB jack.

This two port right angle PCB mount jack is available with either gold or nickel plated outer contacts. This connector is fixed to the PCB with through hole solder pegs and is supplied with circular fixing nuts for attachment to a bulkhead. The centre contact is gold plated.



Part Number	Features
92-52-468-1	Nickel plated outer contacts
92-52-468-2	Gold plated outer contacts

**NEW**

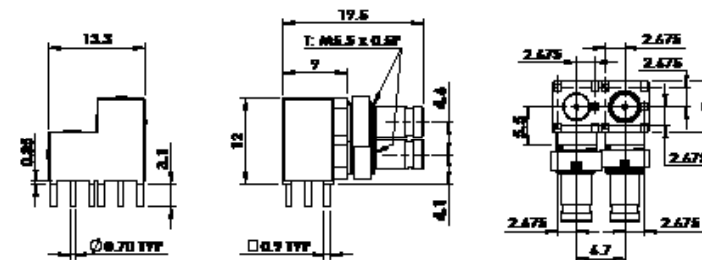



## Straight PCB jack.

Straight PCB jacks shown here have gold plated inner and outer contacts and are available as standard or for bulkhead mounting.

Bulkhead mount versions are supplied complete with a circular slotted locking nut. A tool for tightening this nut (96-1136) can be found in the Accessories & Tooling section of this catalogue.

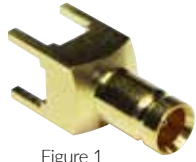

Figure 1



Figure 2

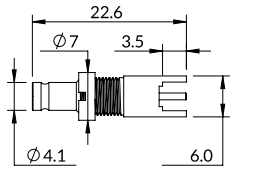

Figure 2

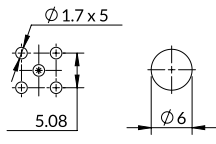
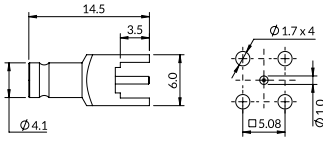

Figure 1



## Right angle PCB bulkhead jack.

This bulkhead PCB jack has gold plated inner and outer contacts and is supplied complete with a circular slotted locking nut.

A tool for tightening this nut (96-1136) can be found in the Accessories & Tooling section of this catalogue.



Part Number	Centre Contact	Outer Contact	Features	Features
52-468-D36	Solder	Solder	Bulkhead mount	Figure 1
52-468-1-D36	Solder	Solder	Bulkhead mount	Figure 2

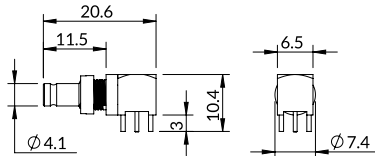

Figure 1

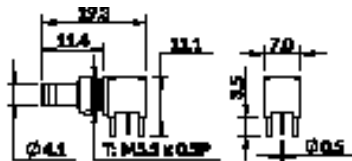
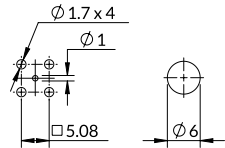
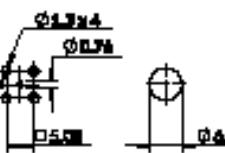

Figure 2



## End launch PCB bulkhead jack.

PCB edge mounted jack for bulkhead fitting, supplied complete with fixing nut and lock washer. A tool for tightening this nut (96-1136) can be found in the Accessories & Tooling section of this catalogue.

These connectors are ideal for use where board space is restricted or low profile mounting is required.

Centre contact and body are gold plated.



Part Number	Centre Contact	Outer Contact	Features
52-463-D36-1.6	Solder	Solder	For 1.6mm board thickness

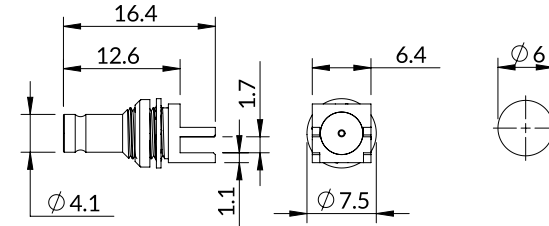

## Isolated Metal Thread Bulkhead Jack to Jack Adaptor (6GHz)

75 ohm Bulkhead Jack to Jack Adaptor with a metal tread that is insulated from the main connector body. This true 75 ohm Adaptor is designed for Full HD 1080p applications and general use up to 6GHz. With gold plated Closed Entry centre contact to prevent mis-mating.

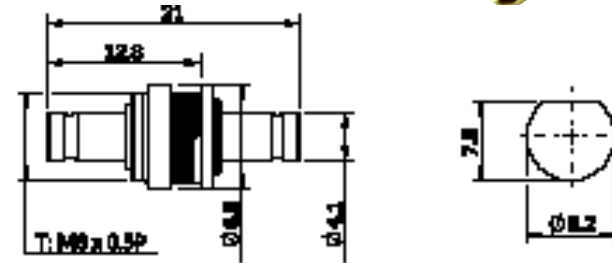

Part Number	Features
52-503- D66	Insulated Bulkhead mount, supplied with lock nut



MCX	Page
Straight cable plug crimp and solder	176
Straight cable jack	177
Right angle cable plug	178
PCB mount	179

## MCX connectors.

MCX are a range of micro miniature connectors typically used in communications applications at frequencies up to 6GHz. MCX connectors, being around 30% smaller are an alternative to the popular SMB connector range.

The reliable snap together interface provides an ideal solution where space is restricted. The right angle versions offer low profile mounting and board space is kept to a minimum.

MCX are widely used in hand-held applications and small devices in many commercial and industrial instruments.

### Key Features:

- Microminiature size
- DC to 6GHz
- Snap together interface

## Specification.

Electrical Specification		Environmental Specification	
Impedance	50 ohm	Operation temperature	-55 to +155 Deg C
Frequency Range	Up to 6GHz	IP Rating (Mated)	N/A
Dielectric Withstand Voltage	500 Veff		
Insulation Resistance	1000 M-ohm		
Mechanical Specification		Materials	
Design Standard	IEC-61169-36	Centre Contact	Phosphur Bronze/ Beryllium Copper
ROHS Compliant	Yes	Outer Contact	Phosphur Bronze/ Brass
Mating Cycles	500	Insulator	PTFE
Contact Retention	10N min	Centre Contact Plating	Gold
Mating Force	<25N max	Outer Contact Plating	Gold
Un-coupling Force	8-20N max		

The above values are typical. Please check product data sheets for full details - see [www.coax-connectors.com](http://www.coax-connectors.com) or call +44(0)20 8538 9090

## MCX interface.

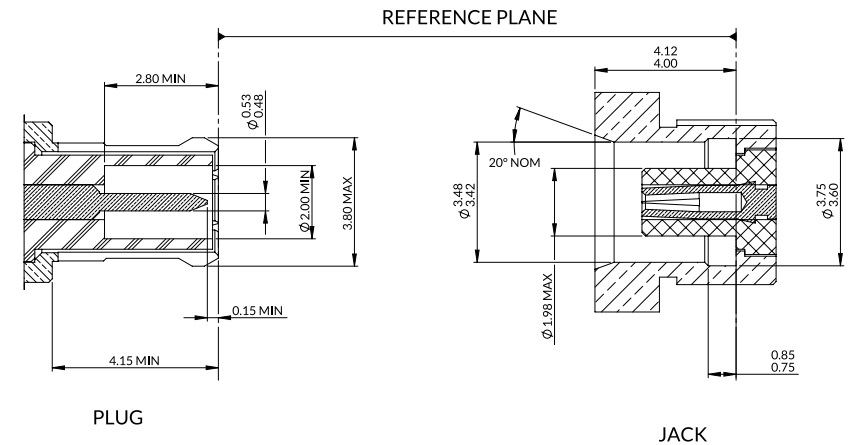

## Straight cable plug crimp and solder.

MCX plugs are available for either flexible or semi-rigid cables. Centre contact and outer body parts are gold plated. Flexible cables are terminated using standard crimp methods whilst connectors for semi-rigid or conformable cables are soldered.

Crimp sizes are shown in the table and suitable tooling can be found in the Accessories & Tooling section of this catalogue.

Part Number	Cable Types (for more see appendix)	$\Omega$	Cable Group	Assembly Procedure	Centre Contact	Outer Contact	Features
45-005-A0-AB	RG179, RG187, Belden 179DT	75	AB	AP001	Indent	3.25 Hex	75 ohm
45-005-D3-AA	RG178, RG196	50	AA	AP001	Indent	3.25 Hex	
45-005-D3-AD	RG174, RG188, RG316, Times LMR®100	50	AD	AP001	Indent	3.25 Hex	
45-005-D3-AE	RD316, RD188	50	AE	AP033	Indent	3.84 Hex	
45-014-D3-HA	RG405(.085")	50	HA	AP033	Solder	Solder	Not shown

For full details of assembly procedures, go to [www.coax-connectors.com/ap](http://www.coax-connectors.com/ap)

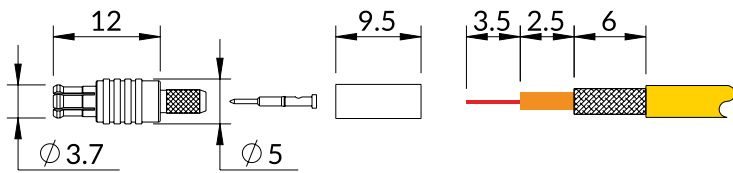

## Straight cable jack.

MCX jacks are available as either free cable connectors or for bulkhead mounting. Options include connectors for fitting to flexible cable using standard crimp methods or for semi-rigid which are soldered.

Bulkhead mounted versions are rear mounted and supplied complete with fixing nut and washer.

Centre contact and outer body parts are gold plated and terminated using standard crimp methods.

Crimp sizes are shown in the table and suitable tooling can be found in the Accessories & Tooling section of this catalogue.



Figure 1

Figure 2

Part Number	Cable Types (for more see appendix)	$\Omega$	Cable Group	Assembly Procedure	Centre Contact	Outer Contact	Features
45-054-D3-AD	See appendix for details on pages 198-203	50	AD	AP001	Indent	3.25 Hex	Figure 1
45-254-D3-AD	See appendix for details on pages 198-203	50	AD	AP001	Indent	3.25 Hex	Figure 2 Bulkhead rear mount
45-347-Q3-HA	RG405(.085")	50	HA	AP033	Solder	Solder	Figure 3 White bronze plated Direct Solder Bulkhead front mount

For full details of assembly procedures, go to [www.coax-connectors.com/ap](http://www.coax-connectors.com/ap)

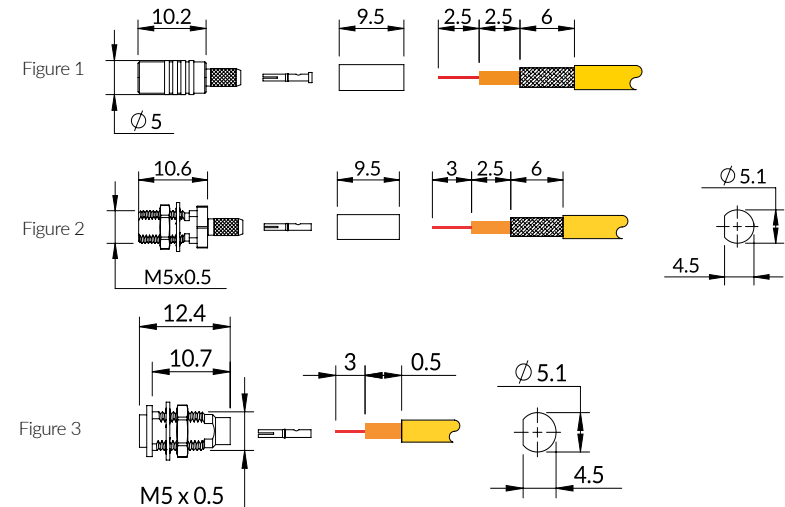

Figure 1

Figure 2

Figure 3

## Right angle cable plug.

MCX right angle plugs offer a low profile solution when mated with PCB jacks.

Options available include connectors for fitting to standard flexible cables or for semi-rigid and conformable cables.

The gold plated centre contacts are soldered; when fitted to flexible cable the outers are crimped whilst those for semi-rigid cables are directly soldered to the body. Outer body parts are gold plated.

Crimp sizes are shown in the table and suitable tooling can be found in the Accessories & Tooling section of this catalogue.

Part Number	Cable Types (for more see appendix)	$\Omega$	Cable Group	Assembly Procedure	Centre Contact	Outer Contact	Features
45-105-D3-AA	RG178, RG196	50	AA	AP017	Solder	3.25 Hex	Figure 1
45-105-D3-AD	See appendix for details on pages 198-203	50	AD	AP017	Solder	3.25 Hex	Figure 1
45-105-D3-AE	RD316, RD188	50	AE	AP017	Solder	3.84 Hex	Figure 1
45-105-D3-AH	RG58, RG141, Times LMR®195	50	AH	AP017	Solder	5.41 Hex	Figure 1
45-105-D6-AB	RG179, RG187, Belden 179DT	75	AB	AP017	Solder	3.25 Hex	Figure 1 75 ohm
45-108-D3-HA	RG405 (.085")	50	HA	AP033	Solder	Solder	Figure 2
45-108-D3-HB	RG402 (.141")	50	HB	AP033	Solder	Solder	Figure 2

For full details of assembly procedures, go to [www.coax-connectors.com/ap](http://www.coax-connectors.com/ap)

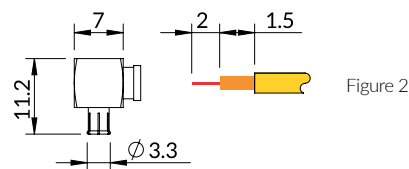
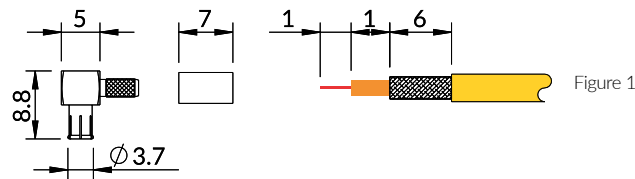

## PCB mount, including edge mount.

MCX connectors for PCB mounting are available in straight, right angle and edge mount styles. Centre contact and body parts are gold plated.

Part Number	$\Omega$	Centre Contact	Outer Contact	Features
45-450-D3	50	Solder	Solder	Figure 1 - Straight Jack
45-450-D6	75	Solder	Solder	Figure 1 - Straight Jack (75 ohm)
45-411-D3	50	Solder	Solder	Figure 2 - Right Angle Plug
45-465-D3	50	Solder	Solder	Figure 3 - Right Angle Jack
45-410-D3-1.6	50	Solder	Solder	Figure 4 - Edge mount jack for 1.6mm thick board
45-410-D66-1.6	75	Solder	Solder	Figure 4 - Edge mount jack for 1.6mm thick board (75ohm)

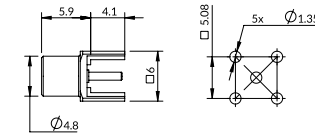

Figure 1

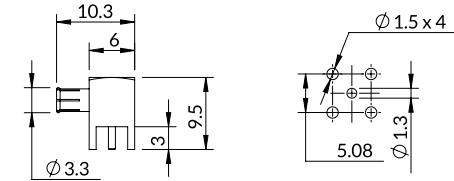

Figure 2

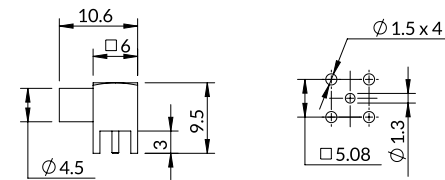

Figure 4

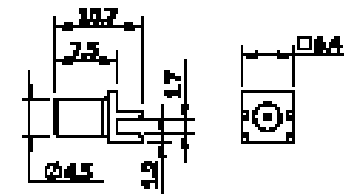

Figure 4



MMCX	Page
Straight cable plug crimp and direct solder	182
Straight cable jack	183
Right angle cable solder crimp plug	184
Right angle PCB plug	185
Straight and right angle PCB jack	185

# MMCX connectors.

MMCX are a range of micro miniature connectors typically used in communications applications at frequencies up to 6GHz. Ideal for use where space is restricted, the right angle versions offer low profile mounting when mated to PCB jacks meaning that board space is kept to a minimum.

The reliable snap together interface allows full 360 degree rotation while mated.

MMCX are widely used in hand-held applications including GPS, industrial control and consumer devices.

## Key Features:

- Microminiature size
- DC to 6GHz
- Snap together interface



## New connectors.

We are regularly designing new connectors to enhance our range, if you can not find what you need, please contact us.

## Specification.

Electrical Specification		Environmental Specification	
Impedance	50 ohm	Operation temperature	-55 to +155 Deg C
Frequency Range	Up to 6GHz	IP Rating (Mated)	N/A
Dielectric Withstand Voltage	500 Veff		
Insulation Resistance	1000 M-ohm		
Mechanical Specification		Materials	
Design Standard	IEC-61169-52	Centre Contact	Beryllium Copper
ROHS Compliant	Yes	Outer Contact	Beryllium Copper/Brass
Mating Cycles	500	Insulator	PTFE
Contact Retention	10N min	Centre Contact Plating	Gold
Mating Force	15N max	Outer Contact Plating	Gold
Un-coupling Force	6-15N max		

The above values are typical. Please check product data sheets for full details - see [www.coax-connectors.com](http://www.coax-connectors.com) or call +44(0)20 8538 9090

## MMCX 50 ohm Interface.

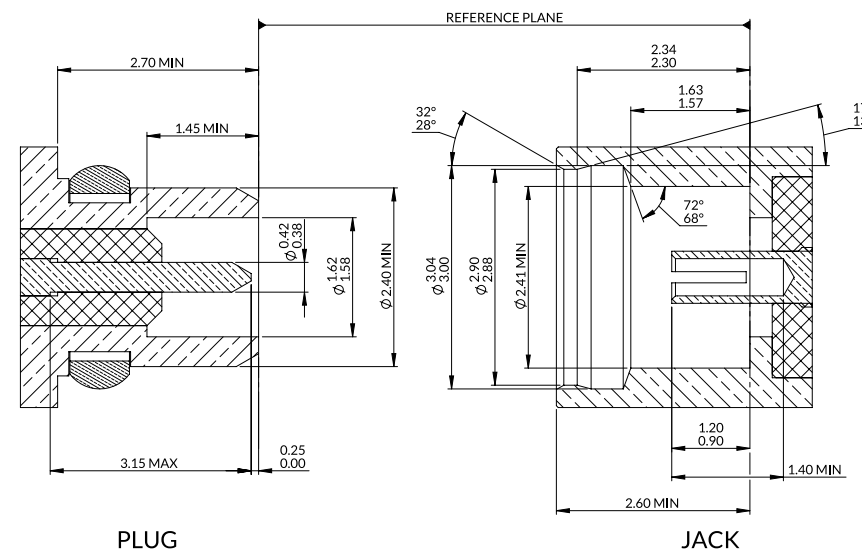



## Straight cable plug crimp and direct solder.

MMCX plugs are available for either flexible or semi-rigid cables. Centre contact and outer body parts are gold plated. Flexible cables are terminated using standard crimp methods whilst connectors for semi-rigid or conformable cables are soldered.

Crimp sizes are shown in the table and suitable tooling can be found in the Accessories & Tooling section of this catalogue.

Part Number	Cable Types (for more see appendix)	Cable Group	Assembly Procedure	Centre Contact	Outer Contact	Features
47-005-D3-AA	RG178, RG196	AA	AP001	Indent	3.25 Hex	
47-005-D3-AB	RG179, RG187, Belden179DT	AB	AP001	Indent	3.25 Hex	
47-005-D3-AD	See appendix for details on pages 198-203	AD	AP001	0.95 Sq	3.25 Hex	
47-005-D3-AE	RD316, RD188	AE	AP001	0.95 Sq	3.84 Hex	
47-014-D3-HA	RG405(.085")	HA	AP033	Solder	Solder	For semi-rigid cable Not shown

For full details of assembly procedures, go to [www.coax-connectors.com/ap](http://www.coax-connectors.com/ap)

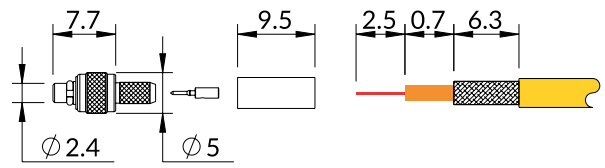

## Straight cable jack.

MMCX jacks are available as either free cable connectors or for bulkhead mounting. Bulkhead mounted versions are rear mounted and supplied complete with fixing nut and washer.

Centre contact and outer body parts are gold plated and terminated using standard crimp methods.

Crimp sizes are shown in the table and suitable tooling can be found in the Accessories & Tooling section of this catalogue.

Part Number	Cable Types (for more see appendix)	Cable Group	Assembly Procedure	Centre Contact	Outer Contact	Features
47-054-D3-AA	RG178, RG196	AA	AP001	Indent	3.25 Hex	Figure 1
47-054-D3-AB	RG179, RG187, Belden179DT	AB	AP001	Indent	3.25 Hex	Figure 1
47-054-D3-AD	See appendix for details on pages 198-203	AD	AP001	0.95 Sq	3.25 Hex	Figure 1
47-054-D3-AE	RD316, RD188	AE	AP001	0.95 Sq	3.84 Hex	Figure 1
47-254-D3-AB	RG179, RG187, Belden179DT	AB	AP001	Indent	3.25 Hex	Figure 2 Bulkhead mount

For full details of assembly procedures, go to [www.coax-connectors.com/ap](http://www.coax-connectors.com/ap)

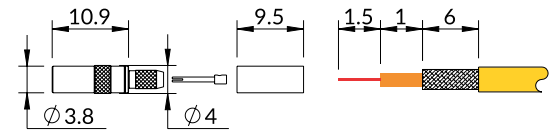

Figure 1

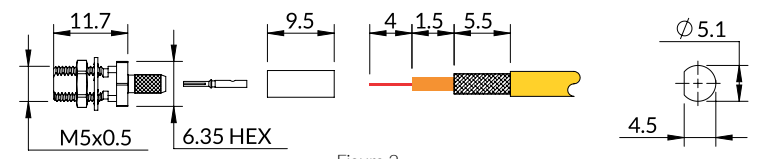

Figure 2



## Right angle cable solder crimp plug.

MMCX right angle plugs offer a low profile solution when mated with PCB jacks.

Centre contact and outer body parts are gold plated, the centre contact is soldered and the outer is hexagon crimped.

Crimp sizes are shown in the table and suitable tooling can be found in the Accessories & Tooling section of this catalogue.

Part Number	Cable Types (for more see appendix)	Cable Group	Assembly Procedure	Centre Contact	Outer Contact	Features
47-105-D3-AA	RG178, RG196	AA	AP017	Solder	3.25 Hex	
47-105-D3-AD	RG174, RG188, RG316, Times LMR®100	AD	AP017	Solder	3.25 Hex	

For full details of assembly procedures, go to [www.coax-connectors.com/ap](http://www.coax-connectors.com/ap)

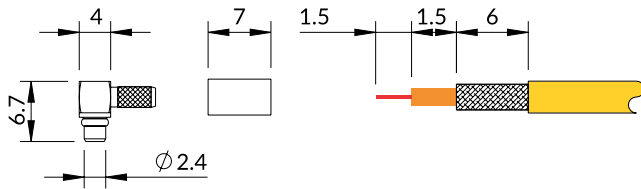

## Right angle PCB plug.

MMCX connectors for PCB mounting are available with gold plated body and centre contacts.

Part Number	Centre Contact	Outer Contact	Features
47-460-D3	Solder	Solder	Plug - Right angle

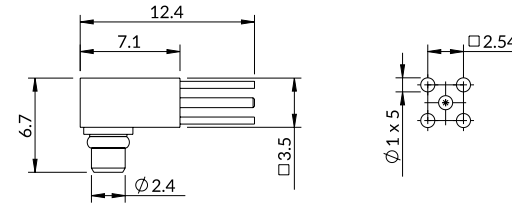

## Straight and right angle PCB jack.

Part Number	Centre Contact	Outer Contact	Features
47-450-D3	Solder	Solder	Figure 1 Jack - Straight
47-465-D3	Solder	Solder	Figure 2 Jack - Right angle

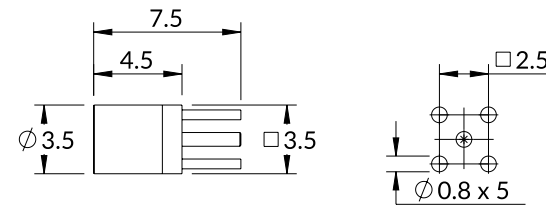

Figure 1

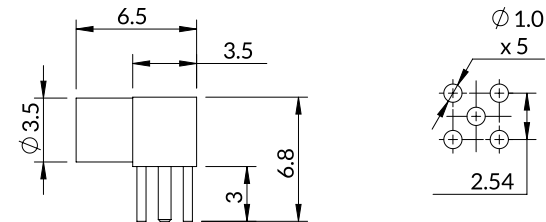

Figure 2

## BMA Connectors.

BMA are a series of blind mate connectors. Similar in size to the SMA series, BMA are high frequency connectors that are ideal for rack and panel and similar applications. Panel mount jacks with slide in interface giving low insertion force and built in float, allow a connector array to be mated together.

Suitable for use up to 12GHz, BMA feature gold plated centre and outer contacts.



## Specification.

Electrical Specification		Environmental Specification	
Impedance	50 ohm	Operation Temperature	-55 to +125 Deg C
Frequency Range	Up to 12GHz	IP Rating (Mated)	N/A
Dielectric Withstand Voltage	300 Veff		
Insulation Resistance	5000 M-ohm		
Mechanical Specification		Materials	
Design Standard	IEC-61169-33	Centre Contact	Phosphur Bronze/ Beryllium Copper
ROHS Compliant	Yes	Outer Contact	Phosphur Bronze
Mating Cycles	500	Insulator	PTFE
Contact Retention	27N	Coupling Nut	Brass
Mating Force	13N	Centre Contact Plating	Gold
Un-coupling Force	6.6N	Outer Contact Plating	Gold

The above values are typical. Please check product data sheets for full details - see [www.coax-connectors.com](http://www.coax-connectors.com) or call +44(0)20 8538 9090

## BMA Interface.

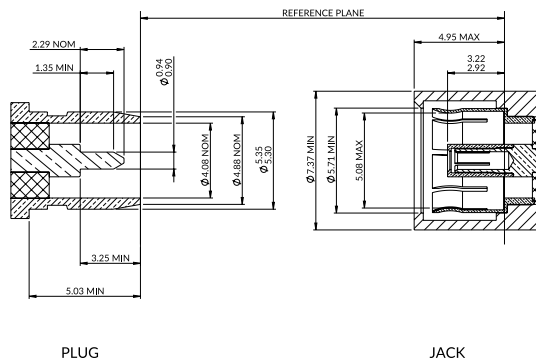

## BMA cable.

The float mount feature of BMA allows an array of panel mounted jacks to mate with PCB mounted plugs. The built in float allows each jack to align correctly to the mating half. The slide in, low insertion force, gold plated interface makes BMA ideal for blind mate applications.

The cable mount jack has crimped centre and outer contacts. Crimp sizes are shown in the table and suitable tooling can be found in the Accessories & Tooling section of this catalogue.

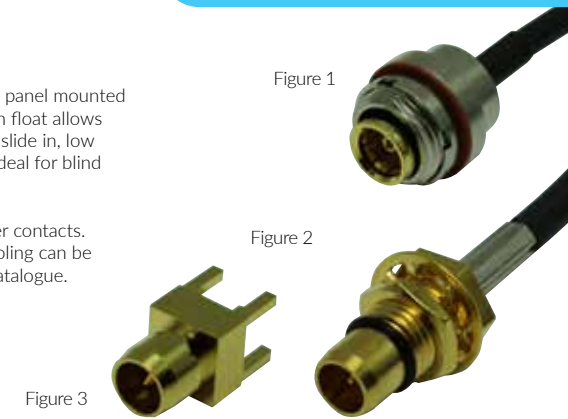

Part Number	Cable Types	Cable Group	Assembly Procedure	Centre Contact	Outer Contact	Features
57-285-D3-AD	See appendix for details on pages 198-203	AD	AP001	1.72 Hex	5.41 Hex	Figure 1 Float mount jack
57-216-D3-AD	See appendix for details on pages 198-203	AD	AP001	1.72 Hex	5.41 Hex	Figure 2 Cable plug
57-400-D3	N/A		AP001	Solder	Solder	Figure 3 PCB plug

For full details of assembly procedures, go to [www.coax-connectors.com/ap](http://www.coax-connectors.com/ap)

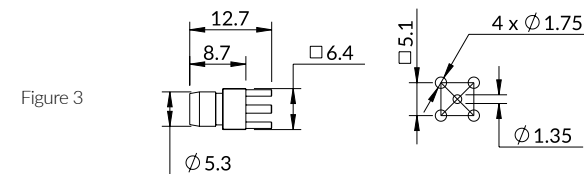
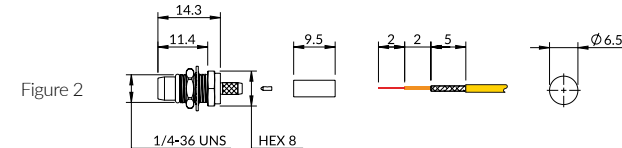
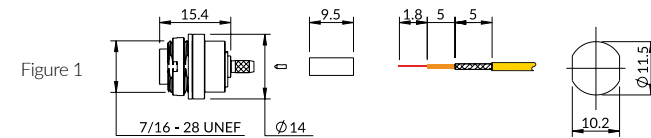



# Inter-Series Adaptors.

A wide selection of adaptors are available to connect between the different connector series.

Select Interface A and B from the table to find the appropriate part number.

Adaptors for interconnection within the same connector series (e.g. BNC to BNC) are shown in the pages for that type.

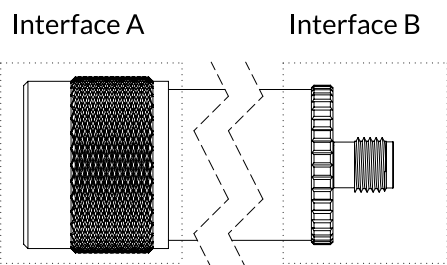

Example only - please select the required configuration from the table.

Part Number	Interface A	Interface B	Impedance	Notes
74-1015-500	BNC Jack	F Type Jack	75 ohm	
74-1015-534	BNC Jack	F Type Plug	75 ohm	
74-1067-534	BNC Jack	Micro BNC Plug	75 ohm	
74-1067-500	BNC Jack	Micro BNC Jack	75 ohm	
74-1025-534	BNC Jack	N Type Plug	50 ohm	
74-1017-534	BNC Jack	Phono Plug	50 ohm	
74-1030-534-B3	BNC Jack	SMA Plug	50 ohm	
74-1013-534	BNC Jack	TNC Plug	50 ohm	
74-1020-534	BNC Jack	UHF Plug	50 ohm	
74-1029-535	BNC Jack	DIN 41626 Plug	75 ohm	Bulkhead mount
74-1052-500	BNC Jack	DIN 1.0/2.3 Jack	75 ohm	6GHz
74-1052-534-B36	BNC Jack	DIN 1.0/2.3 Plug	75 ohm	6GHz

Part Number	Interface A	Interface B	Impedance	Notes
74-1016-511	BNC Plug	Euro Jack	50 ohm	
74-1016-514	BNC Plug	Euro Plug	50 ohm	
74-1015-511	BNC Plug	F Type Jack	75 ohm	
74-1022-514	BNC Plug	FME Plug	50 ohm	
74-1067-514	BNC Plug	Micro BNC Plug	75 ohm	3GHz
74-1067-511	BNC Plug	Micro BNC Jack	75 ohm	4.5GHz
74-1025-511	BNC Plug	N Type Jack	50 ohm	
74-1025-511-75R	BNC Plug	N Type Jack	75 ohm	⚠ Do not mate with 50ohm
74-1025-514	BNC Plug	N Type Plug	50 ohm	
74-1025-514-75R	BNC Plug	N Type Plug	75 ohm	⚠
74-1017-511	BNC Plug	Phono Jack	50 ohm	
74-1017-514	BNC Plug	Phono Plug	50 ohm	
74-1030-511	BNC Plug	SMA Jack	50 ohm	
74-1030-514-B3	BNC Plug	SMA Plug	50 ohm	
74-1020-511	BNC Plug	UHF Jack	50 ohm	
74-1052-511-B36	BNC Plug	DIN 1.0/2.3 Jack	75 ohm	6GHz
74-1525-534	F Type Jack	N Type Plug	75 ohm	⚠
74-1520-534	F Type Jack	UHF Plug	75 ohm	⚠ Bulkhead Mount
74-1525-511	F Type Plug	N Type Jack	75 ohm	⚠ Do not mate with 50ohm
74-2225-534	FME Plug	N Type Jack	50 ohm	
74-2225-514	FME Plug	N Type Plug	50 ohm	
74-2213-514	FME Plug	TNC Plug	50 ohm	
74-2022-514	FME Plug	UHF Plug	50 ohm	
74-2122-514	FME Plug	UHF Plug	50 ohm	
74-2555-500-E3	N Type Jack	7/16 Jack	50 ohm	
74-2555-534	N Type Jack	7/16 Plug	50 ohm	
74-2530-500	N Type Jack	SMA Jack	50 ohm	
74-2530-501-B3	N Type Jack	SMA Jack	50 ohm	Bulkhead mount
74-2584-534-G3	N Type Jack	LC Plug	50 ohm	Silver plated contacts
74-2530-534	N Type Jack	SMA Plug	50 ohm	
74-2555-511-P3	N Type Plug	7/16 Jack	50 ohm	
74-2530-511	N Type Plug	SMA Jack	50 ohm	
74-2530-514	N Type Plug	SMA Plug	50 ohm	
74-1330-500	TNC Jack	SMA Jack	50 ohm	
74-1330-534	TNC Jack	SMA Plug	50 ohm	
74-1325-511	TNC Plug	N Type Jack	50 ohm	
74-1325-511-H3	TNC Plug	N Type Jack	50 ohm	18GHz
74-1330-511	TNC Plug	SMA Jack	50 ohm	
74-1330-511-H3	TNC Plug	SMA Jack	50 ohm	18GHz
43-76A	Type 43 Plug	BNC Plug	75 ohm	
74-2030-534	UHF Jack	SMA Plug	50 ohm	
74-2025-514	UHF Plug	N Type Jack	50 ohm	
74-3132-541	SMA RP Jack	SMB Jack	50 ohm	IP68 Bulkhead mount
74-5130-501	MMBX Jack	SMA Jack	50 ohm	Bulkhead mount

⚠ Damage may occur if 50 and 75 ohm connectors are mixed.

## Cable joiner.

These coaxial cable joiners provide a low loss method of making a permanent connection between 2 cables of the same type.

Cable joiners are ideal for repair and maintenance of damaged cables, or to aid re-routing when it is necessary to cut the cable.

These joiners use crimping to terminate the centre conductors and a clamp mechanism for the outer which also provides an IP68 seal.



Part Number	Cable Types (for more see appendix)	Cable Group	Assembly Procedure	Centre Contact	Outer Contact	Features
76-570-Q3-AH	RG58, RG141, Times LMR@195	AH	AP035	1.72 Hex	Clamp	Figure 1 50 ohm
76-570-Q6-AI	RG59, RG62, URM70	AI	AP035	1.72 Hex	Clamp	Figure 2 75 ohm

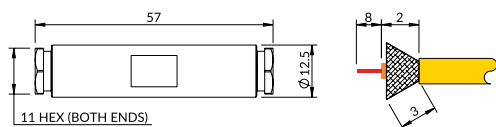

Figure 1

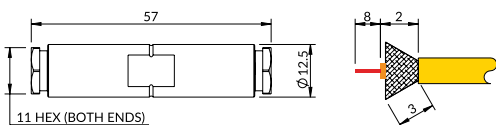

Figure 2

## Cable terminator.

Right angled coaxial terminator, for fixing of coaxial cable directly on to a PCB.

Coaxial terminators are ideal where a permanent, low loss and reliable fitting to a PCB is required.

The cable is attached to the terminator by soldering the braid and centre conductor, which is then through hole soldered onto the PCB.



Part Number	Cable Types (for more see appendix)	Cable Group	Assembly Procedure	Centre Contact	Outer Contact	Features
77-495-R3-AD	See appendix for details on pages 198-203	AD	AP034	Solder	Solder	

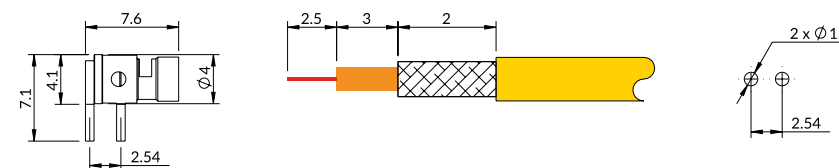



## Patch cables.

Patch cables in a range of standard lengths are available with BNC, TNC, SMA and N Type connectors fitted to both ends. These standard cables are fitted with a supporting cable boot.

Other connector combinations, marker sleeves and different cable length or types are available on request, please contact us to discuss the options.

Part Number	Length (cut cable length before assembly)	Cable Type	Connector end A	Connector end B
90-10A10A-12D-C1-100	1 Metre	RG179	BNC Plug (10-005-B36-AB)	BNC Plug (10-005-B36-AB)
90-10A10A-12D-C1-200	2 Metres			
90-10A10A-12D-C1-500	5 Metres			
90-10A10A-12D-C1-1000	10 Metres			
90-10A10A-04A-C1-100	1 Metre	RG58	BNC Plug (10-005-A3-AH)	BNC Plug (10-005-A3-AH)
90-10A10A-04A-C1-200	2 Metres			
90-10A10A-04A-C1-500	5 Metres			
90-10A10A-04A-C1-1000	10 Metres			
90-13A13A-04A-C1-100	1 Metre	RG58	TNC Plug (13-005-A3-AH)	TNC Plug (13-005-A3-AH)
90-13A13A-04A-C1-200	2 Metres			
90-13A13A-04A-C1-500	5 Metres			
90-13A13A-04A-C1-1000	10 Metres			
90-25A25A-04A-C1-100	1 Metre	RG58	N Type Plug (25-005-B3-AH)	N Type Plug (25-005-B3-AH)
90-25A25A-04A-C1-200	2 Metres			
90-25A25A-04A-C1-500	5 Metres			
90-25A25A-04A-C1-1000	10 Metres			
90-30A30A-04A-S1-100	1 Metre	RG58	SMA Plug (30-005-B3-AH)	SMA Plug (30-005-B3-AH)
90-30A30A-04A-S1-200	2 Metres			
90-30A30A-04A-S1-500	5 Metres			
90-30A30A-04A-S1-1000	10 Metres			

All the above patch cables are manufactured using standard black jacket RG179 or RG58 Length indicated is cut cable length before connector is fitted. Marker sleeves and cable boots can be fitted if required, please contact us for details.

## Adaptor cables.

To avoid complete cable replacement when new routers and ancillary equipment is being installed, use our adaptor cables to change between connector types.

Standard adaptor cables, using high performance cable from group FA, 0.6/2.8 with a green jacket are available in a several different lengths to convert from standard BNC to Micro BNC or DIN 1.0/2.3.

Other combinations and different cable types are available on request, please contact us to discuss the options.



Part Number	Length (cut cable length before assembly)	Connector end A	Connector end B
90-67A10D-62-A1-50	0.5 Metre	Micro BNC Plug (67-005-B66-FA)	BNC Jack (10-054-B36-FA)
90-67A10D-62-A1-100	1 Metre		
90-67A10D-A62-1-30	12 inch		
90-67A10D-62-A1-91	36 inch		
90-67A10A-62-A1-50	0.5 Metre	Micro BNC Plug (67-005-B66-FA)	BNC Plug (10-005-B36-FA)
90-67A10A-62-A1-100	1 Metre		
90-67A10A-62-A1-30	12 inch		
90-67A10A-62-A1-91	36 inch		
90-52A10D-62-A1-50	0.5 Metre	DIN 1.0/2.3 Plug (52-005-B6-FA)	BNC Jack (10-054-B36-FA)
90-52A10D-62-A1-100	1 Metre		
90-52A10D-62-A1-30	12 inch		
90-52A10D-62-A1-91	36 inch		
90-52A10A-62-A1-50	0.5 Metre	DIN 1.0/2.3 Plug (52-005-B6-FA)	BNC Plug (10-005-B36-FA)
90-52A10A-62-A1-100	1 Metre		
90-52A10A-62-A1-30	12 inch		
90-52A10A-62-A1-91	36 inch		

All the above adaptor cables are manufactured using cable from group FA. Length indicated is cut cable length before connector is fitted. Marker sleeves and cable boots can be fitted if required, please contact us for details.

Inner Conductor Solid bare copper wire, diameter 0.6 mm  
 Insulation Foam-PE, diameter 2.8 mm  
 Outer Conductor Al-PET-Al-foil under tinned copper braid  
 Jacket Diameter 4.5 mm, Green  
 Minimum Bending Radius 25mm



## Crimp tools.

A wide range of hand held crimp tools for centre contacts and/or crimp sleeves for the crimp connectors supplied by COAX Connectors.

Part Number	Description	Crimp die sizes
96-HTS-43	Type 43 Ratchet Crimp Tool	0.95sq, 3.25, 4.52 & 5.18 mm A/F hex
96-HTS-75A	Ratchet Crimp Tool for True 75 ohm DIN1.0/2.3, Micro BNC & BNC	0.95sq, 1.07 sq, 1.72, 5.41 & 8.23mm A/F hex
96-HTS-76	Ratchet Crimp Tool for True 75 ohm DIN1.0/2.3, Micro BNC & BNC	0.95sq, 1.72, 5.41 & 6.48 mm A/F hex
96-HTS-77	Ratchet Crimp Tool with US standard die sizes.	1.07sq, 4.52, 6.48 & 7.06 mm A/F hex
96-106G	Crimp Tool 106G	2.54, 8.20 & 11.4 mm A/F hex
96-106L	Crimp Tool 106L	2.54, 9.12 & 10.3 mm A/F hex
96-106Q	Crimp Tool 106Q	8.23 & 11.94 mm A/F hex
96-336A	Ratchet Crimp Tool 336A	1.72, 5.41 & 6.50 mm A/F hex
96-336A4	Ratchet Crimp Tool 336A4	1.72, 4.75, 5.41 & 6.48 mm A/F hex
96-336C2	Ratchet Crimp Tool 336C2	1.72, 6.65, 8.23 & 9.14 mm A/F hex
96-336D	Ratchet Crimp Tool 336D	1.72, 5.41, 6.50 & 8.23 mm A/F hex
96-336G	Ratchet Crimp Tool 336G	1.09sq, 1.72, 2.54, 3.48, 5.41 & 6.48 mm A/F hex
96-336I	Ratchet Crimp Tool 336I	1.70, 2.36, 5.41, 6.46 & 8.00 mm A/F hex
96-336J	Ratchet Crimp Tool 336J	1.07sq, 1.72, 1.98, 3.25, 3.88 & 4.52 mm A/F hex
96-336K	Ratchet Crimp Tool 336K	2.54, 3.25 & 10.9 mm A/F hex
96-336P1	Ratchet Crimp Tool 336P1	1.72, 2.49, 5.41, 6.48 & 8.15 mm A/F hex
96-336T1	Ratchet Crimp Tool 336T1	0.71sq, 0.99sq, 1.19sq, 2.54, 3.25 & 3.84 mm A/F hex
96-336Y	Ratchet Crimp Tool 336Y	1.12, 1.45, 1.72, 5.41 & 5.59 mm A/F hex
96-568R	Ratchet Crimp Tool - RJ45	Not applicable



## Tool kit. Part Number 96-330K

Tool Kit includes a Ratchet Crimp tool with a selection of interchangeable crimp dies, a Rotary Cable Stripper and a Cable Cutter.

Supplied in a rugged tool box, the kit includes everything you need to terminate the majority of coaxial cable connectors.

The 5 interchangeable die sets cover 15 different hexagon and square sizes, from 1.07mm (0.042") square to 10.9mm (0.429") hex.

## Extraction / insertion tools.

Tools designed for extracting and/or inserting connectors used in high density applications where there is insufficient room for finger access.



96-1023	1.0/2.3 Extractor Tool
96-1132	Micro BNC Plug Insertion & Extractor Tool
96-1137	Micro BNC Plug Insertion & Extractor Tool (for use with larger cables)
96-1132-150	Micro BNC Plug Insertion & Extractor Tool - 150mm long version
96-2208	BNC Insertion & Extractor Tool 8" (200mm)
96-310-832-Tool	HDC 43 T Bar Insertion & Extractor Tool
96-310-831-Tool	Extractor 65A for removing Plug 43/GTIS

## Cable strippers.

Hand held rotary cable strippers for preparing cables prior to termination onto connectors.



96-312B	Rotary Cable Stripper, RG58, 59, URM70
96-312S	Rotary Cable Stripper for RG213 Cable
96-312D	Rotary Cable Stripper, RG179
96-312X	Rotary Cable Stripper, Mini 59
96-322	Rotary Cable Stripper, RG58, 59, URM70

## Other tools & parts

100-1023	1.0/2.3 Crimp contact alignment tool
96-1135	Slotted nut runner for Micro BNC bulkhead fixing nut 6.4mm x 7.5mm x 2mm
96-1136	Slotted nut runner for 1.0/2.3 bulkhead fixing nut 6.4mm x 7.5mm x 1.5mm
96-1140	Slotted nut runner for BNC & TNC bulkhead fixing nut with recess to hold nut
96-1142	Slotted nut runner for Micro BNC & DIN1.0/2.3 bulkhead adaptor 8.8mm x 8mm x 1.5mm
100-075	Circular slotted nut for BNC/TNC for use where space is limited





## Accessories.

Black protective PVC caps offer general protection when fitted to the interface of a connector.

Available in a wide range of sizes, these caps can be used to protect most coaxial connectors in this catalogue.



Part Number	Diameter in mm	Length in mm	Fits Connector
100-121	9.7	12	BNC & TNC Jacks
100-122	14.0	15	BNC & TNC Plug
100-123	20.5	15	N Type Plug & UHF Plug
100-124	8.2	10	SMA Plug
100-125	33.0	15	7/16 Plug
100-126	28.0	13	7/16 Jack
100-127	2.6	9	
100-128	2.9	10	SMB & SMC
100-129	8.5	20	F Type Jack & Mini BNC Plug
100-130	9.5	16	Type 43 (SMZ) Socket
100-131	11.0	20	F Type Plug
100-132	15.5	20	N Type Jack & UHF Jack
100-133	16.0	20	
100-134	18.0	30	
100-135	6.5	18	BMA Jack & 1.0/2.3 Plug Micro BNC Plug
100-136	6.0	18	SMA Jack, Micro BNC Jack, SMB Plug & Type 43 (SMZ) Plug
100-137	13.0	12	
100-138	14.0	12	

Not all connectors in a series are covered by a single specification and dimensions may vary. Please check actual connector size before selecting the above items.

## Cable boots.



Boots for other cables available on request. Please contact COAX for details.

Part Number	Cable Type	Colour
97-800-XX-05	RG58	Available in 10 colours: Black (BK), Brown (BN), Blue (BU), Green (GN), Grey (GY), Orange (OR), Red (RE), Violet (VI), White (WH) and Yellow (YE)
97-800-XX-06	RG59	
97-800-XX-03	RG174/179	Available in 5 colours: BK, BU, GN, RE, YE

Replace XX in part number with appropriate code as shown in colour column.

# Bespoke cable assemblies

See page 6



**COAX**  
CONNECTORS LTD

The information contained in this appendix is compiled from a variety of sources and is not a complete list. Cable and connector compatibility should always be checked before starting production. Coax connectors Ltd., accept no responsibility for the accuracy of this data.

Cable Type	Impedance	Jacket	Dielectric		Centre Conductor		Shielding
	Ω	Diameter mm	Material	Diameter mm	Material	Diameter mm	
<b>Cable Group AA</b>							
RG178	50	1.8	PTFE	0.84	SCCS	0.3	Cu Braid
RG196	50	1.83	PTFE	0.86	SCCS	0.3	Cu Braid
<b>Cable Group AB</b>							
Belden 179DT	75	2.54	PEF	1.42	BC	0.31	Foil & Braid
RG179	75	2.54	PTFE	1.6	SCCS	0.3	Cu Braid
RG187	75	2.67	PTFE	1.52	SCCS	0.3	Cu Braid
<b>Cable Group AC</b>							
RD179	75	3.02	PTFE	1.6	SCCS	0.3	2 x Cu Braid
<b>Cable Group AD</b>							
KX22	50	2.5	PTFE	1.52	SCCS	0.51	Cu Braid
KX3	50	2.54	PE	1.5	CCS	0.48	Cu Braid
RG174	50	2.79	PE	1.52	BCCS	0.48	Cu Braid
RG188	50	2.67	PTFE	1.52	SCCS	0.51	Cu Braid
RG316	50	2.49	PTFE	1.52	SCCS	0.51	Cu Braid
Times LMR®100	50	2.79	PE	1.52	BCCS	0.46	Foil & Braid
URM95	50	2.3	PE	1.5	SCCS	0.46	Cu Braid
WBC100	50	2.67	PE	1.52	CCS	0.46	Foil & Braid
<b>Cable Group AE</b>							
RD188	50	2.9	PTFE	1.52	SCCS	0.51	2 x Cu Braid
RD316	50	2.9	PTFE	1.52	SCCS	0.51	2 x Cu Braid
<b>Cable Group AF</b>							
Mini RG59 Black	75	4.15	PEF	2.9	CCS	0.64	Foil & Braid
<b>Cable Group AG</b>							
Mini RG59 White	75	3.6	PEF	1.9	CCS	0.41	Foil & Braid
<b>Cable Group AH</b>							
Belden 9203	50	4.95	PE	2.95	TC	0.9	Cu Braid
KX15	50	4.95	PE	2.95	TC	0.91	Cu Braid
KX23	50	5.1	PTFE	2.95	SC	1.02	2 x Cu Braid
PSF 1/6	50	5	PE	2.95	BC	0.96	2 x Cu Braid
RG141	50	4.83	PTFE	3	SCCS	0.94	Cu Braid
RG58	50	4.95	PE	2.95	TC	0.91	Cu Braid
Times LMR®195	50	4.95	PEF	2.79	BC	0.94	Foil & Braid
URM43	50	5	PE	2.95	BC	0.9	Cu Braid
URM76	50	5	PE	2.95	TC	0.96	Cu Braid
WBC195	50	4.95	PE	2.79	BC	0.94	Foil & Braid
<b>Cable Group AI</b>							
CanfordLV-61S	75	6.1	PE	3.6	BC	0.6	Braid
KX52	75	-	-	-	-	-	-
KX6	75	6.1	PE	3.7	BC	0.6	CuBraid
RG59	75	6.15	PE	3.71	BCCS	0.57	CuBraid
RG59U	75	6.15	PE	3.71	BCCS	0.57	CuBraid
URM104	75	6	PE	-	-	0.64	CuBraid
URM70	75	5.8	PE	3.25	TC	0.6	CuBraid
KX30	93	6.15	PE	3.71	BCCS	0.64	CuBraid
RG62	93	6.15	PE	3.71	BCCS	0.64	CuBraid

The information contained in this appendix is compiled from a variety of sources and is not a complete list. Cable and connector compatibility should always be checked before starting production. Coax connectors Ltd., accept no responsibility for the accuracy of this data.

Cable Type	Impedance	Jacket	Dielectric		Centre Conductor		Shielding
	Ω	Diameter mm	Material	Diameter mm	Material	Diameter mm	
<b>Cable Group AJ</b>							
RG59DB	75	6.15	PE	3.7	CCS	0.58	CuBraid
<b>Cable Group AK</b>							
RG223	50	5.38	PE	2.95	SC	0.89	2 xCuBraid
<b>Cable Group AL</b>							
RD178	50	3.7	PTFE	0.87	SCSC	0.3	2 xCuBraid
<b>Cable Group AM</b>							
KX8	75	10.3	PE	7.25	BC	1.2	CuBraid
RG11	75	10.29	PE	7.24	TC	1.2	CuBraid
<b>Cable Group AN</b>							
KX4	50	10.3	PE	7.25	BC	2.25	CuBraid
RG213	50	10.29	PE	7.24	BC	2.25	CuBraid
URM67	50	10.3	PEF	7.25	BC	2.25	Cu Braid
<b>Cable Group AO</b>							
RG214	50	10.8	PE	7.24	SC	2.25	2 xCuBraid
<b>Cable Group AP</b>							
URM202	75	5.1	PEF	3.25	BC	0.75	CuBraid
<b>Cable Group AR</b>							
RGC8-50J	50	10.24	Foam	7.37	BC	2.74	Foil&Braid
RGC8-CCA-50J	50	10.24	Foam	7.37	CCA	2.74	Foil&Braid
<b>Cable Group AS</b>							
RG7	95	9.4	PE	6.35	BC	0.91	CuBraid
<b>Cable Group AT</b>							
RG11RBS	75	11.5	PE	7.24	TC	1.2	CuBraid
<b>Cable Group AU</b>							
RG142	50	4.95	PTFE	2.95	CCS	0.94	2 xCuBraid
RG400	50	4.95	PTFE	2.95	SCCS	0.97	2 xCuBraid
<b>Cable Group BA</b>							
BT2001	75	4.4	PEF	2.4	BC	0.6	Cu Braid
<b>Cable Group BB</b>							
BT2002	75	5.1	PEF	2.4	BC	0.63	2 x Cu Braid
<b>Cable Group BC</b>							
BT2003	75	6.65	PE	3.7	BC	0.61	2 x Cu Braid
PSF 1/3	75	6.4	PE	3.7	BC	0.61	2 x Cu Braid
<b>Cable Group BD</b>							
BT3002	75	3.55	PE	1.95	BC	0.31	2 x Cu Braid
TZC75024	75	3.55	PE	1.95	BC	0.31	2 x Cu Braid
TZC75025	75	4.55	PE	2.95	BC	0.32	2 x Cu Braid
<b>Cable Group BE</b>							
BT5000	75	7.2	PEF	4.8	BC	0.96	Foil & Braid
RA5000	75	7.2	PEF	4.8	BC	0.96	Foil & Braid
<b>Cable Group BF</b>							
BT7000	75	4.55	PEF	2.8	BC	0.61	Foil & Braid
RA7000	75	4.55	PEF	2.8	BC	0.61	Foil & Braid
<b>Cable Group BG</b>							
RA8000	75	2.75	PEF	1.45	BC	0.31	Foil & Braid

The information contained in this appendix is compiled from a variety of sources and is not a complete list. Cable and connector compatibility should always be checked before starting production. Coax connectors Ltd., accept no responsibility for the accuracy of this data.

Cable Type	Impedance	Jacket	Dielectric		Centre Conductor		Shielding
	Ω	Diameter mm	Material	Diameter mm	Material	Diameter mm	
<b>Cable Group BH</b>							
735A	75	3.28	PEF	1.96	SPC	0.41	Foil & Braid
Canford SDV-M	75	3.1	FHPE	1.9	BC	0.41	Foil & Braid
CT1320	75	3.28	PEF	1.96	SPC	0.41	Foil & Braid
Draka 0.41/1.9 AF	75	3.1	PEF	1.9	BC	0.41	Foil & Braid
<b>Cable Group BI</b>							
1.6mm Mini Coax	75	1.6	PEF	1.1	BC	0.26	Cu Braid
<b>Cable Group BJ</b>							
2.2mm Mini Coax	75	2.2	PEF	1.2	BC	0.26	Cu Braid
<b>Cable Group CA</b>							
CT100	75	6.5	PEF	4.45	BC	1	Foil & Braid
RG6	75	6.99	PEF	4.57	BC	1.02	Foil & Braid
WSC100	75	6.65	PEF	4.7	CCS	1.02	Foil & Braid
<b>Cable Group CB</b>							
CT100RBS	75	8.5	PEF	4.6	BC	1	Foil & Braid
<b>Cable Group CC</b>							
CT125	75	7.8	PEF	5.5	BC	1.25	Foil & Braid
<b>Cable Group CD</b>							
CT125RBS	75	9.6	PEF	5.6	BC	1.25	Foil & Braid
<b>Cable Group CE</b>							
CT167	75	10.1	PEF	7.28	BC	1.67	Foil & Braid
<b>Cable Group CF</b>							
CT167RBS	75	11.5	PEF	7.28	BC	1.67	Foil & Braid
<b>Cable Group CY</b>							
CYG014	75	6	PEF	2.3	TC	0.5	Cu Braid
<b>Cable Group DA</b>							
Times LMR@200	50	4.95	PEF	2.95	BC	1.12	Foil & Braid
<b>Cable Group DB</b>							
Belden 155 A00	50	5.4	PEF	3.9	BC	1.41	Foil & Braid
Belden 155 PE	50	10.3	PEF	3.9	BC	1.4	Foil & Braid
Times LMR@240	50	6.1	PEF	3.81	BC	1.42	Foil & Braid
<b>Cable Group DC</b>							
Times LMR@300	50	7.62	PEF	4.83	BC	1.78	Foil & Braid
<b>Cable Group DE</b>							
Belden 7810A	50	10.24	PE	7.24	BCCAI	2.74	Foil & Braid
Belden 9913	50	10.29	PE	7.26	BC	2.74	Cu Braid
Belden H1000PE	50	10.3	PEF	7.15	BC	2.62	Foil & Braid
RG8	50	10.24	PE	7.24	BC	2.62	Foil & Braid
Times LMR@400	50	10.29	PEF	7.24	BCCAI	2.74	Foil & Braid
Times LMR@400 Ultraflex	50	10.29	PEF	7.24	BC	2.74	Foil & Braid
TZC50032	50	10.3	PE	7.24	BC	2.74	Cu Braid
<b>Cable Group DG</b>							
Times LMR@500	50	12.7	PEF	9.4	BCCAI	3.61	Foil & Braid
<b>Cable Group DH</b>							
Times LMR@600	50	14.99	PEF	11.56	BCCAI	4.47	Foil & Braid

The information contained in this appendix is compiled from a variety of sources and is not a complete list. Cable and connector compatibility should always be checked before starting production. Coax connectors Ltd., accept no responsibility for the accuracy of this data.

Cable Type	Impedance	Jacket	Dielectric		Centre Conductor		Shielding
	Ω	Diameter mm	Material	Diameter mm	Material	Diameter mm	
<b>Cable Group DJ</b>							
Times LMR@1200	50	30.48	PEF	23.4	BC Tube	8.86	Foil & Braid
<b>Cable Group DL</b>							
Times LMR@200-75	75	4.95	PEF	2.95	BC	0.64	Foil & Braid
<b>Cable Group DM</b>							
Times LMR@400-75	75	10.29	PEF	7.24	BC	1.65	Foil & Braid
<b>Cable Group EF</b>							
Belden 1855A	75	4.04	PEF	2.59	BC	0.58	Foil & Braid
Belden 1865A	75	3.81	PEF	2.39	BC	0.54	Foil & Braid
Belden 4855R	75	4.04	FHPE	2.59	BC	0.58	Foil & Braid
<b>Cable Group EG</b>							
RG59U Quad Shield	75	6.73	PEF	3.66	CCS	0.81	2 x Foil & Braid
<b>Cable Group EH</b>							
Flex 3	75	3.6	PE	2.3	BC	0.4	Foil & Braid
<b>Cable Group FA</b>							
Belden 1855ENH	75	4.45	PEF	2.8	TC	0.6	Foil & Braid
Belden H123A02	75	4.3	PEF	2.9	CU	0.65	Foil & Braid
Bryant BD SD01	75	4.5	PEF	2.8	BC	0.6	Foil & Braid
Canford SDV	75	4.5	PEF	2.8	BC	0.6	Foil & Braid
Canford SDV-LFH	75	4.6	PEF	2.8	BC	0.6	Foil & Braid
Canford SDV-X-LFH	75	4.5	PEF	2.8	BC	0.64	Foil & Braid
Conducfil 9890	75	4.5	PEF	2.8	BC	0.6	Foil & Braid
Draka 0.6/2.8AF	75	4.5	PEF	2.8	BC	0.6	Foil & Braid
Draka HD PRO 0.6/2.8AF	75	4.5	PEF	2.8	BC	0.6	Foil & Braid
Draka Ultra HD Pro 50	75	4.5	PEF	2.9	SC	0.7	Foil & Braid
Image 360	75	4.6	PEF	2.95	BC	0.6	Foil & Braid
Percon VK4	75	4.4	PEF	2.6	BC	0.57	Foil & Braid
Percon VK5	75	4.5	PEF	2.8	BC	0.57	Foil & Braid
Percon VK50 Silver+	75	4.5	PEF		SC	0.57	Foil & Braid
Van Damme SDI Vision	75	4.5	PEF	2.8	BC	0.6	Foil & Braid
<b>Cable Group FB</b>							
70081NH	75	5.92	PEF	3.68	BC	0.81	Foil & Braid
Belden 1505A	75	5.94	PEF	3.68	BC	0.81	Foil & Braid
Belden 4505R	75	5.94	PEF	3.68	BC	0.81	Foil & Braid
Belden 70081NH	75	5.92	PEF	3.68	BC	0.81	Foil & Braid
Bryant BD SD50A	75	6.1	PEF	3.7	BC	0.8	Foil & Braid
Canare L-4CFB	75	6.1	PEF	3.7	BC	0.8	Foil & Braid
Canford SDV-I-X-LFH	75	5.9	PEF	3.7	BC	0.8	Foil & Braid
Conducfil 14472	75	5.9	PEF	3.7	BC	0.8	Foil & Braid
Draka 0.8/3.7AF	75	5.9	PEF	3.7	BC	0.8	Foil & Braid
Draka HD PRO 0.8/3.7 AF	75	5.9	PEF	3.7	BC	0.8	Foil & Braid
Image 720	75	5.9	PEF	3.7	BC	0.8	Foil & Braid
Percon VK6	75	6	PEF	3.7	BC	0.81	Foil & Braid
Percon VK66	75	6.14	PEF	3.7	BC	0.97	2 x Cu Braid

The information contained in this appendix is compiled from a variety of sources and is not a complete list. Cable and connector compatibility should always be checked before starting production. Coax connectors Ltd., accept no responsibility for the accuracy of this data.

Cable Type	Impedance	Jacket	Dielectric		Centre Conductor		Shielding
	Ω	Diameter mm	Material	Diameter mm	Material	Diameter mm	
<b>Cable Group FC</b>							
70082NH	75	6.96	PEF	4.57	BC	1.02	Foil & Braid
Belden 1694F	75	7.01	PEF	4.57	BC	1.02	2 x Cu Braid
Belden 4694R	75	6.98	PEF	4.57	BC	1.02	Cu Braid
Bryant BD SD10F	75	7	PEF	4.57	BC	1.1	2 x Cu Braid
Bryant BD SD11	75	6.8	PEF	4.45	BC	1.02	Foil & Braid
Canford SDV-L	75	6.8	FHPE	4.8	BC	1.0	Foil & Braid
Canford SDV-L-LFH	75	6.8	FHPE	4.8	BC	1.0	Foil & Braid
Canford SDV-L-RR	75	10.4	FHPE	4.8	BC	1.0	Foil & Braid
Canford SDV-L-SR	75	6.8	FHPE	4.8	BC	1.0	Foil & Braid
Canford SDV-L-X-LFH	75	7	FHPE	4.8	BC	1.0	Foil & Braid
Conducfil 13653	75	6.8	PEF	4.45	BC	1.02	Foil & Braid
Draka 1.0/4.8 AF	75	7	PEF	4.8	BC	1.0	Foil & Braid
Draka HD PRO 1.0/4.8 AF	75	7	PEF	4.8	BC	1.0	Foil & Braid
Image 1000	75	6.8	PEF	4.8	BC	1.0	Foil & Braid
Percon VK7	75	7	PEF	4.7	BC	1.02	Foil & Braid
Percon VK70 ENH	75	7.1	PEF	4.7	BC	1.02	Foil & Braid
Percon VK77	75	7	PEF	4.7	BC	1.08	2 x Cu Braid
<b>Cable Group FD</b>							
Belden 7731A	75	10.2	PEF	7.11	BC	1.63	Foil & Braid
Bryant BD SD70	75	10.1	PEF		BC	1.63	Foil & Braid
Canford SDV-HD	75	10.2	FHPE	7.5	BC	1.63	Foil & Braid
Canford SDV-HD-LFH	75	10.2	FHPE	7.5	BC	1.63	Foil & Braid
Draka 1.6/7.3 AF	75	10.3	PEF	7.3	BC	1.6	Foil & Braid
Image 2000	75	10.3	PEF	7.3	BC	1.6	Foil & Braid
<b>Cable Group FE</b>							
Belden 1505F	75	6.15	PEF	3.68	BC	0.79	2 x Cu Braid
Bryant BD SD50F	75	6.15	PEF	3.68	BC	0.79	2 x Cu Braid
<b>Cable Group FF</b>							
Draka 1.2L/4.8DZ	75	7.2	PEF	4.8	BC	1.2	2 x Cu Braid
Draka Ultra HD Pro 100	75	7	PEF	4.9	SC	1.2	Foil & Braid
Sommer 600-0214	75	7.1	PEF	4.8	BC	1.2	2 x Cu Braid
<b>Cable Group FG</b>							
CM2231	75	6	PE	3.8	CU		Foil & Braid
CM3641	75	6	PE	3.8	CU		Foil & Braid
<b>Cable Group FH</b>							
Conducfil 14510	75	9.2	PEF	6.4	BC	1.4	Foil & Braid
Conducfil 14511	75	9.2	PEF	6.4	BC	1.4	Foil & Braid
<b>Cable Group FI</b>							
Belden 1794A	75	8.13	PEF	5.72	BC	1.29	Foil & Braid
Belden 4794R	75	8.13	FHPE	5.72	SPC	1.29	Foil & Braid
<b>Cable Group GA</b>							
PSF 1/2	75	7.5	PE	4.85	BC	0.8	2 x Cu Braid
<b>Cable Group HA</b>							
RG405 (.085")	50	2.2	PTFE	1.68	SCCS	0.51	Solid Cu Tube

The information contained in this appendix is compiled from a variety of sources and is not a complete list. Cable and connector compatibility should always be checked before starting production. Coax connectors Ltd., accept no responsibility for the accuracy of this data.

Cable Type	Impedance	Jacket	Dielectric		Centre Conductor		Shielding
	Ω	Diameter mm	Material	Diameter mm	Material	Diameter mm	
<b>Cable Group HB</b>							
RG402 (.141")	50	3.58	PTFE	3.02	SCCS	0.91	Solid Cu Tube
<b>Cable Group HC</b>							
RG401 (.250")	50	6.35	PTFE	5.31	SC	1.63	Solid Cu Tube
SCF14-50J 1/4" CELLFLEX	50	7.8	Foam	4.3	CCA	1.9	Solid Cu Tube
<b>Cable Group HD</b>							
0.047" Semi-Rigid	50	1.194	PTFE	0.94	SCCS	0.287	Solid Cu Tube
<b>Cable Group JD</b>							
Percon VK60 Silver+	75	5.9	PEF		SC	0.81	Foil & Braid
<b>Cable Group JC</b>							
Percon VK70 Silver+	75	7.1	PEF		SC	1.02	Foil & Braid
<b>Cable Group JD</b>							
Percon VK80 Silver+	75	9.2	PEF		SC	1.29	Foil & Braid
<b>Cable Group JF</b>							
Percon VK90 Silver+	75	10.5	PEF		SC	1.63	Foil & Braid



# Part Number Index

Part Number	Page	Part Number	Page	Part Number	Page	Part Number	Page	Part Number	Page	Part Number	Page	Part Number	Page	Part Number	Page	Part Number	Page	Part Number	Page
10-001-A0-AI	34	10-054-A0-AI	38	10-470-1-X36	47	13-278-A3-AD	72	25-005-B3-AK	99	30-005-D3-DA	117	32-054-B3-AB	140	45-105-D3-AD	178	67-005-B66-BH	56	90-10A10A-04A-C1-1000	192
10-001-A3-AH	15	10-054-A0-BC	38	10-470-2-B36	45	13-279-B3-HA-17.5mm	72	25-005-B3-AO	99	30-005-D3-DB	117	32-054-B3-AD	140	45-105-D3-AE	178	67-005-B66-EF	56	90-10A10A-04A-C1-200	192
10-002-A3-AH	15	10-054-A0-FC	38	10-470-B36	44	13-283-B3-HA-17.5mm	72	25-005-B3-AN	99	30-008-D3-AH	117	32-054-B3-AE	140	45-105-D3-AH	178	67-005-B66-FA	56	90-10A10A-12D-C1-100	192
10-002-B3-AN	15	10-054-A3-AH	18	10-471-K1	43	13-322-B3-AD	71	25-005-B3-AU	99	30-014-D3-DA	118	32-101-D3-AA	139	45-105-D6-AB	178	67-005-B66-FB	56	90-10A10A-12D-C1-1000	192
10-004-A0-AI	34	10-054-A3-AK	18	10-471-K5	23	13-350-A3	71	25-005-B3-DA	99	30-014-D3-HA	118	32-105-D3-AB	139	45-108-D3-BA	178	67-005-B66-FC	56	90-10A10A-12D-C1-200	192
10-004-A0-AB	34	10-054-A3-AN	18	10-471-K6	43	13-355-A3	71	25-005-B3-DB	99	30-014-D3-HB	118	32-105-D3-AD	139	45-108-D3-HB	178	67-005-B66-FB1	56	90-10A10A-12D-C1-500	192
10-004-A0-CB	34	10-054-A3-AP	18	10-473-A3	22	13-410-1.57mm-Q3	73	25-005-B3-DC	99	30-018-B3-DE	116	32-105-D3-AE	139	45-254-D3-AD	177	67-005-B66-FC	56	90-10A10A-12D-C1-100	192
10-004-A0-CD	34	10-054-B36-AB	38	10-482-B36	44	13-468-A3	73	25-005-B3-DE	99	30-054-B3-DE	122	32-105-D3-BD	139	45-47-Q3-HA	177	67-005-B66-FC1	56	90-13A13A-04A-C1-100	192
10-005-A0-AF	33	10-054-B36-AI	40	10-486-1-B36	40	13-500-A3	74	25-005-B6-AB	99	30-054-D3-AA	122	32-105-D3-BG	139	45-410-D3-1.6	179	67-005-B66-FE	56	90-13A13A-04A-C1-200	192
10-005-A0-AG	33	10-054-B36-BC	38	10-486-B36	41	13-500-B36	74	25-005-B6-AI	99	30-054-D3-AD	122	32-105-D6-AC	139	45-410-D6-1.6	179	67-005-B66-FE	56	90-13A13A-04A-C1-1000	192
10-005-A0-AI	33	10-054-B36-BD	38	10-487-B36	42	13-501-A3	74	25-006-B3-AD	99	30-054-D3-AE	122	32-254-A3-AD	140	45-411-D3	179	67-005-B66-JC	56	90-13A13A-04A-C1-500	192
10-005-A0-AJ	33	10-054-B36-FC	38	10-491-B6	41	13-503-B126	74	25-006-B3-AE	99	30-054-D3-AA	122	32-254-B3-AA	140	45-50-D3	179	67-054-B66-FC1	57	90-25A25A-04A-C1-100	192
10-005-A0-AM	14	10-054-D126-FA	38	10-491-B6-45	41	13-514-A3	74	25-014-B3-HA	99	30-054-D3-AK	122	32-254-B3-AB	140	45-50-D6	179	67-054-B66-FA	57	90-25A25A-04A-C1-500	192
10-005-A0-AT	14	10-055-A0-AI	38	10-500-A3	25	13-520-1-Y3	74	25-014-B3-HB	99	30-063-D3-HA	122	32-271-D3-AD	141	45-465-D3	179	67-054-B66-FB	57	90-25A25A-04A-C1-1000	192
10-005-A0-BC	33	10-055-A0-AD	18	10-500-B36	49	13-520-A3	74	25-017-B3-DE	101	30-068-B3-DE	124	32-271-D3-AD	141	47-005-D3-AA	182	67-054-B66-FB1	57	90-25A25A-04A-C1-500	192
10-005-A0-CA	33	10-055-B36-BF	38	10-500-B66	49	14-005-A3-AH	77	25-017-B3-DG	101	30-069-D3-AD	122	32-369-D3	142	47-005-D3-AB	182	67-054-B66-FC	57	90-30A30A-04A-S1-100	192
10-005-A0-CB	33	10-056-B36-AB	38	10-500-D66	49	14-005-A3-AK	77	25-017-B3-DH	101	30-105-D3-AA	119	32-371-D3	142	47-005-D3-AD	182	67-054-B66-FC1	57	90-30A30A-04A-S1-500	192
10-005-A0-CC	33	10-056-B36-BG	38	10-500-W126	49	14-005-B3-DE	77	25-018-B3-DE	101	30-105-D3-AB	119	32-450-D3	143	67-043-D126	62	67-043-D126-1.6	62	90-30A30A-04A-S1-100	192
10-005-A0-CD	33	10-104-A0-AI	36	10-501-A3	25	14-006-A3-AD	77	25-025-B3-DC	99	30-105-D3-AE	119	32-450-D6	143	67-049-D126-1.6	62	67-463-1-D66-1.6mm	59	90-30A30A-04A-S1-500	192
10-005-A3-AH	14	10-104-A0-BC	36	10-501-A6	49	14-050-A3-AH	78	25-030-B3-DC	105	30-105-D3-AH	119	32-454-D0	143	67-454-D66	58	90-52A10A-62-A1-100	193		
10-005-A3-AN	14	10-104-A0-BD	36	10-501-B36	49	14-054-A3-AK	78	25-030-B3-AN	105	30-105-D3-AK	119	32-465-D0	144	67-454-D66	58	90-52A10A-62-A1-30	193		
10-005-A3-AO	14	10-104-A0-BA	36	10-503-A3	25	14-054-B3-AN	78	25-050-B3-AN	105	30-108-D3-HA	118	32-468-D3	144	67-454-D66	58	90-52A10A-62-A1-50	193		
10-005-A3-AP	14	10-104-A3-AH	17	10-503-A6	49	14-054-B3-DE	78	25-051-B3-AN	105	30-108-D3-HB	118	32-470-D3	144	67-454-D66	58	90-52A10A-62-A1-91	193		
10-005-A3-AU	14	10-104-A3-AK	17	10-503-B36	49	14-055-A3-AD	78	25-054-B3-AD	104	30-254-D3-AD	123	32-501-D3	145	67-468-3-D66	58	90-52A10A-62-A1-100	193		
10-005-A3-DB	14	10-104-B66-AB	36	10-503-D66	49	14-254-A3-AH	79	25-054-B3-AH	104	30-254-D3-AE	123	32-514-D3	145	67-468-D66	58	90-52A10A-62-A1-30	193		
10-005-A3-DE	14	10-104-W66-AB	36	10-503-W126	49	14-254-B3-AH	79	25-054-B3-AN	104	30-254-D3-AH	123	32-522-D3	145	67-468-D66	58	90-52A10A-62-A1-50	193		
10-005-A6-AB	33	10-104-W66-FA	36	10-514-A3	25	14-254-A3-AD	79	25-054-B3-AN	104	30-254-D3-AK	123	32-523-D3	145	67-476-D64-12.25	58	90-52A10A-62-A1-91	193		
10-005-A6-CA	33	10-104-W66-FB	36	10-519-B66	49	15-004-ZO-AG	83	25-054-B3-AO	104	30-256-B3-AA	123	34-001-D3-AH	148	67-476-D64-8.3	58	90-67A10A-62-A1-100	193		
10-005-A7-BD	33	10-104-W66-FC	36	10-519-D66	49	15-005-A6-AB	83	25-054-B3-DB	104	30-256-D3-AA	123	34-005-C3-AD	148	67-503-D126	63	90-67A10A-62-A1-30	193		
10-005-A9-DN	33	10-105-B3-AI	17	10-520-A0	49	15-005-B36-1-FA	83	25-054-B3-DE	104	30-266-D3-HA	123	34-005-D3-AA	148	67-512-B66	63	90-67A10A-62-A1-50	193		
10-005-B36-1-AB	32	10-105-B3-DE	17	10-520-A3	25	15-005-B36-1-FE	83	25-054-B6-AI	104	30-266-D3-HB	123	34-005-D6-AC	148	67-863-B36	63	90-67A10A-62-A1-91	193		
10-005-B36-AB	32	10-106-A0-AB	36	10-520-B66	49	15-005-B36-AB	83	25-067-B3-DH	105	30-282-D3-AA	123	34-105-D3-AD	148	67-863-B36	63	90-67A10A-62-A1-100	193		
10-005-B36-AI	32	10-106-A0-AD	36	10-520-W66	49	15-005-B36-FA	83	25-068-B3-DE	105	30-290-D10-AD	123	34-254-D3-AD	149	67-863-B36	63	90-67A10A-62-A1-30	193		
10-005-B36-BC	32	10-254-A0-AG	39	10-522-A3	25	15-005-B36-FC	83	25-101-B3-AN	102	30-319-D3	119	34-350-D3	149	67-863-B36	63	90-67A10A-62-A1-50	193		
10-005-B36-BD	32	10-254-A0-AI	39	10-523-A3	25	15-005-B36-FC	83	25-101-B3-DE	102	30-321-D3	119	34-371-D3	149	67-863-B36	63	90-67A10A-62-A1-91	193		
10-005-B36-BF	32	10-254-A0-BC	39	10-526-A3	25	15-005-B36-FG	83	25-105-A3-AH	102	30-323-D3	119	43-011-D6-AB	152	67-863-B36	63	90-67A10A-62-A1-100	193		
10-005-B36-BG	32	10-254-A0-BA	39	10-527-A3	25	15-005-B36-FG	83	25-105-A3-AU	102	30-348-D3	125	43-011-D6-BD	152	67-863-B36	63	90-67A10A-62-A1-30	193		
10-005-B36-BH	32	10-254-A3-AH	19	10-538-W66	49	15-015-ZO-AI	82	25-105-B3-AD	102	30-349-D3	125	43-011-D6-BC	152	67-863-B36	63	90-67A10A-62-A1-50	193		
10-005-B36-CY	32	10-254-A3-AU	19	10-550-B36	49	15-015-ZO-AN	82	25-105-B3-AE	102	30-352-D3	125	43-011-D6-BF	152	67-863-B36	63	90-67A10A-62-A1-91	193		
10-005-B36-EG	32	10-254-A6-BD	39	10-550-W126	49	15-015-ZO-AS Bulk	82	25-105-B3-AK	102	30-360-D3	125	43-011-D6-BG	152	67-863-B36	63	90-67A10A-62-A1-100	193		
10-005-B36-FA	32	10-254-B36-FA	39	10-863-T6	47	15-015-ZO-CA	82	25-105-B3-AN	102	30-368-B3	130	43-011-D6-BI	152	67-863-B36	63	90-67A10A-62-A1-30	193		
10-005-B36-FB	32	10-254-B36-FC	39	10-863-W126	47	15-015-ZO-CC	82	25-105-B3-AK	102	30-368-D3	130	43-011-D6-BJ	152	67-863-B36	63	90-67A10A-62-A1-50	193		
10-005-B36-FC	32	10-256-A0-AB	39	11-005-A3-AH	26	15-015-ZO-CE	82	25-109-B3-AO	102	30-372-D3	130	43-012-D6-AB	156	67-863-B36	63	90-67A10A-62-A1-91	193		
10-005-B36-FD	32	10-256-A0-AD	39	11-005-A3-AK	26	15-024-ZO-CC	82	25-109-B3-BO	102	30-375-D3	130	43-012-D6-AC	156	67-863-B36	63	90-67A10A-62-A1-100	193		
10-005-B36-FE	32	10-258-A3-AH	19	11-254-A3-AH	27	15-026-D6-FA	83	25-110-B3-DB	102	30-390-D3-1.6	128	43-012-D6-BD	156	67-863-B36	63	90-67A10A-62-A1-30	193		
10-005-B36-FF	32	10-258-A3-AI	19	11-254-A3-AK	27	15-027-ZO-CA	83	25-233-A3	103	30-410-1-D3	129	43-012-D6-BE	156	67-863-B36	63	90-67A10A-62-A1-50	193		
10-005-B36-FH	32	10-258-B36-FA	39	13-001-A3-AH	67	15-501-A0	82	25-254-B3-AN	106	43-012-D3	129	43-012-D6-BG	156	67-863-B36	63	90-67A10A-62-A1-91	193		
10-005-B36-FW	14	10-258-B36-FW	39	13-001-A3-AE	67	15-514-A6	82	25-254-B3-DB	106	43-027-D3-1.22	120	43-012-D6-BI	156	67-863-B36	63	90-67A10A-62-A1-100	193		
10-005-B3-EH	33	10-258-B36-FB	39	13-001-A3-AI	67	16-020-A0-AI	84	25-255-B3-AD	106	43-028-D3-1.6	120	43-012-D6-BJ	156	67-863-B36	63	90-67A10A-62-A1-30	193		
10-005-B6-BA	33	10-258-B36-FBW	39	13-005-A0-AB	66	16-020-A0-CA	84	25-255-B3-AH	106	43-040-D3	126	43-014-D6-AB	158	67-863-B36	63	90-67A10A-62-A1-50	193		
10-005-B6-DL	33	10-258-B36-FC	39	13-005-A0-AI	66	16-500-A0	84	25-255-B3-AK	106	43-044-D3	126	43-014-D6-BD	158	67-863-B36	63	90-67A10A-62-A1-91	193		
10-005-D126-EF1	31	10-258-B36-FC-W	39	13-005-A0-AM	66	18-005-D36-AB	87	25-255-B3-DE	106	43-054-D3-5.7	126	43-016-D6-AB	158	67-863-B36	63	90-67A10A-62-A1-100	193		
10-005-D126-FA	31	10-260-A3-AD	19	13-005-A3-AH	66	18-054-D36-AB	87	25-255-H3-HA	106	43-055-D3	126	43-060-D6-BD	153	67-863-B36	63	90-67A10A-62-A1-30	193		
10-005-D126-FB	31	10-264-A3-AI	19	13-005-A3-AN	66	18-154-D6-HB	87	25-255-H3-HB	106	43-059-D3 - 1.6mm	128	43-060-D6-BE	153	67-863-B36	63	90-67A10A-62-A1-50	193		
10-005-D126-FB1	31	10-268-A3-AD	18	13-005-A3-AO	66	18-403-D6	86	25-278-B3-AE	107	43-062-1-D3-1.6	129	43-060-D6-BF							

# Product safety notice.

The following warning statement must be read in conjunction with the product data sheet or catalogue. Failure to observe this information and the operating conditions specified could result in hazardous conditions.

## Application.

RF connectors are generally used in low voltage circuits, however care should be taken to ensure that any connector with an exposed contact is not used when hazardous voltages are possible and the touching of a contact could cause an electric shock. Voltages in excess of 30 Vac or 42.5 Vdc are potentially hazardous and care should be taken to ensure that such voltages cannot be transmitted in any way to exposed metal parts of the connector body. Before making live, the connector and wiring should be checked for no damage to metal parts or insulators, no solder blobs, loose strands, conducting lubricants, swarf, or any other undesired conducting particles. Circuit resistance and continuity check should be made to ensure that there are no high resistance joints or spurious conducting paths. Always use the correct application tools as specified in the Data Sheet or Catalogue. Do not permit untrained personnel to wire, assemble or tamper with connectors. For operation voltage please see appropriate national regulations.

## Materials & form.

Electrical connectors do not usually contain hazardous materials. They contain conducting and non-conducting materials and are usually manufactured from either: copper, copper alloys, nickel, zinc, alumel, chromel or steel. In special applications, other alloys may be specified.

## Fire & electric shock hazard.

There is no fire hazard when the connector is correctly wired and used within the specified parameters. Incorrect wiring or assembly of the connector or careless use of metal tools or conductive fluids, or transit damage to any of the component parts may cause electric shock or burns. Live circuits must not be broken by separating mated connectors as this may cause arcing, ionization and burning. Heat dissipation is greater at maximum resistance in a circuit. Hot spots may occur when resistance is raised locally by damage, e.g. cracked or deformed contacts, broken strands of wire. Local overheating may also result from the use of the incorrect application tools or from poor quality soldering or slack screw terminals. Overheating may occur if the ratings in the product Data Sheet or Catalogue are exceeded and can cause breakdown of insulation and hence electric shock. If heating is allowed to continue it intensifies by further increasing the local resistance through loss of temper of spring contacts, formation of oxide film on contacts and wires and leakage currents through carbonisation of insulation and tracking paths. Fire can then result in the presence of combustible materials and this may release noxious fumes. Overheating may not be visually apparent. Burns may result from touching overheated components.

## Handling.

Care must be taken to avoid damage to any component parts of electrical connectors during installation and use. Although there are normally no sharp edges, care must be taken when handling certain components to avoid injury to fingers. Electrical connectors may be damaged in transit to the customers, and damage may result in creation of hazards. Products should therefore be examined prior to installation/use and rejected if found to be damaged.

## Disposal.

Burning of certain materials may release noxious or toxic fumes.

## Important information.

Operating voltage: The admissible operating voltages depend on the individual applications and the valid national and other applicable safety regulations. For this reason, operating voltages, where quoted, are reference values only.

## General information.

COAX Connectors Limited continuously works to improve their products. Therefore, COAX Connectors Limited products may deviate from the description, technical data and shape as shown in this catalogue and data sheets.

## Product warranty.

COAX Connectors Limited manufactures high quality products; however these products are intended to be used in accordance with the product data sheet and assembly procedure. Any use or application that deviates from the stated operating specifications is not recommended and may be unsafe. No information and data contained in this publication shall be construed to create any liability on the part of COAX Connectors Limited. A limited warranty applies to COAX Connectors Limited products. Except for obligations assumed by COAX Connectors Limited under this warranty, COAX Connectors Limited shall not be liable for any loss, damage, cost of repairs, incidental or consequential damages of any kind, whether or not based on express or implied warranty contract, negligence or strict liability arising in connection with the design, manufacture, sale, use or repair of the products. This publication is not to be construed as an offer, it is intended merely as an invitation to make an offer. By this publication, COAX Connectors Limited does not assume responsibility or any liability for any patent infringements or other rights of third parties which may result from its use. Reprinting this publication is generally permitted by indicating the source, however, prior consent must be obtained from COAX Connectors Limited, in all cases.

# Quality Performance Reliability

Whether you need advice on connectors, cable assemblies, wish to place an order or discuss a bespoke solution, our team of experienced engineers, technical advisors and designers are here to take your call.

+44 (0)20 8538 9090

info@coax-connectors.com

**COAX**  
CONNECTORS LTD

# COAX

CONNECTORS LTD

[www.coax-connectors.com](http://www.coax-connectors.com)

COAX Connectors Ltd.  
6-8 Colne Road  
Twickenham  
Middlesex TW1 4JR

t : +44 (0)20 8538 9090

e: [info@coax-connectors.com](mailto:info@coax-connectors.com)



95Q13579 & 95E13579